

# Secure Reliable Transport Protocol

*Derived from the UDP-based Data Transfer protocol, SRT is a user-level protocol that retains most of the core concepts and mechanisms while introducing several refinements and enhancements, including control packet modifications, improved flow control for handling live streaming, enhanced congestion control, and a mechanism for encrypting packets. This document describes the SRT protocol itself. A fully functional reference implementation can be found at <https://github.com/Haivision/srt>.*

## Introduction

SRT is a transport protocol that enables the secure, reliable transport of data across unpredictable networks, such as the Internet. While any data type can be transferred via SRT, it is particularly optimized for audio/video streaming.

SRT can be applied to contribution and distribution endpoints as part of a video stream workflow to deliver the best possible quality and lowest latency video at all times.

As packets are streamed from a source to a destination device, SRT detects and adapts to the real-time network conditions between the two endpoints. SRT helps compensate for jitter and bandwidth fluctuations due to congestion over noisy networks. Its error recovery mechanism minimizes the packet loss typical of Internet connections. And SRT supports AES encryption for end-to-end security.

SRT has its roots in the UDP-based Data Transfer (UDT) protocol. While UDT was designed for high throughput file transmission over public networks, it does not do well with live video. SRT is a significantly modified version that supports live video streaming.

Low latency video transmission across IP based networks typically takes the form of MPEG-TS unicast or multicast streams using the UDP protocol. This solution is perfect for protected networks, where any packet loss can be mitigated by enabling forward error correction (FEC). Achieving the same low latency between sites in different cities, countries or even continents is more challenging. While it is possible with satellite links or dedicated MPLS networks, these are expensive solutions. The use of cheaper public internet connectivity, while less expensive, imposes significant bandwidth overhead to achieve the necessary level of packet loss recovery.

Even though UDT was not designed for live streaming, its packet loss recovery mechanism provided an interesting starting point. The original version of SRT included new packet retransmission functionality that reacted immediately to packet loss to enable live streaming.

To achieve low latency streaming, SRT had to address timing issues. The characteristics of a stream from a source network are completely changed by transmission over the public internet, which introduces delays, jitter, and packet loss. This, in turn, leads to problems with decoding, as the audio and video decoders do not receive packets at the expected times. The use of large buffers helps, but latency is increased.

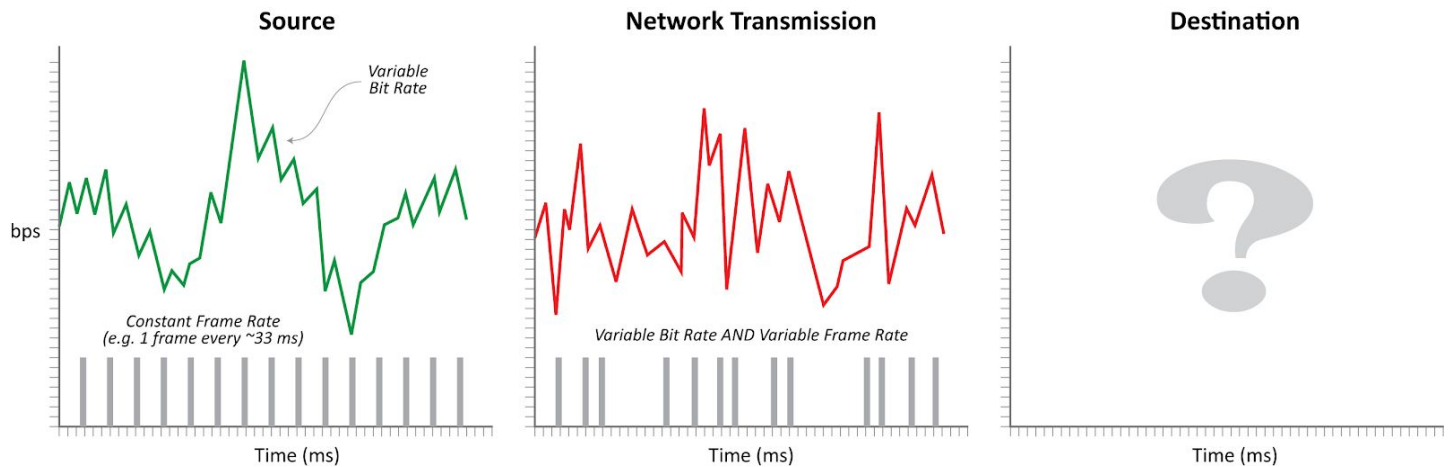

SRT includes a mechanism that recreates the signal characteristics on the receiver side, dramatically reducing the need for buffering. This functionality is part of the SRT protocol itself, so once data comes out of an SRT connection on the receiver side, the stream characteristics have been properly recovered.

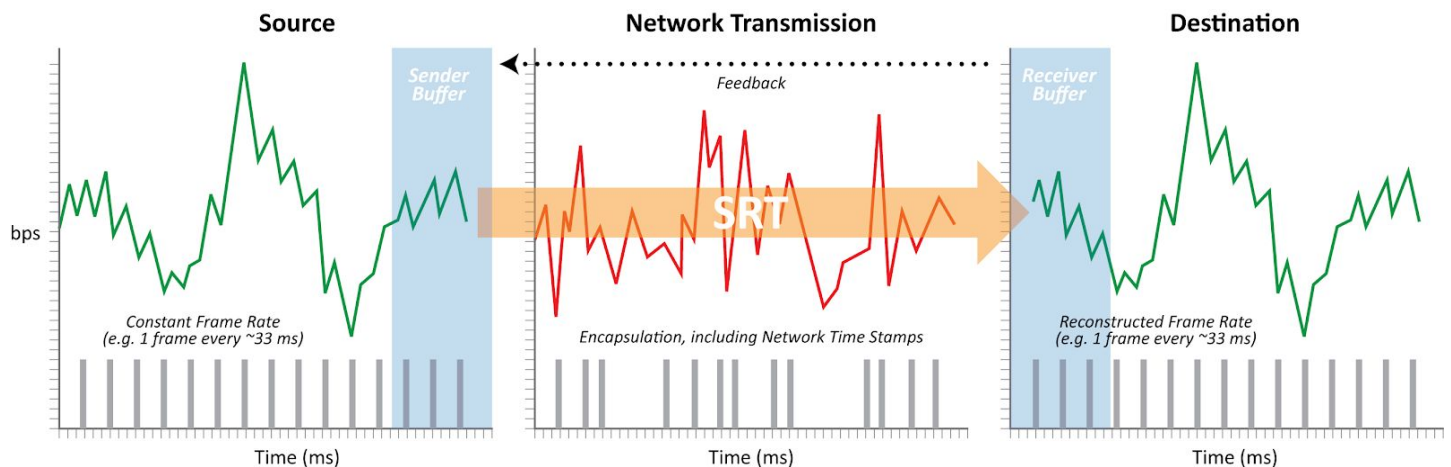

Initially developed by Haivision Systems Inc., the SRT protocol was released as open source in April 2017 in partnership with Wowza Media Systems Inc. Open source SRT is distributed under MPL-2.0, which was chosen because it strikes a balance between driving adoption for open source SRT, while encouraging contributions to improve upon it by the community of adopters. Any third party is free to use the SRT source in a larger work regardless of how that larger work is compiled. Should they make source code changes, they would be obligated to make those changes available to the community.

In May 2017, Haivision and Wowza founded the SRT Alliance ([www.srtalliance.org](http://www.srtalliance.org)), a consortium dedicated to the continued development and adoption of the protocol.

## Table of Contents

<b>Introduction</b>	<b>1</b>
<b>Table of Contents</b>	<b>3</b>
<b>Adaptation of UDT4 to SRT</b>	<b>6</b>
<b>Packet Structure</b>	<b>8</b>
Data and Control Packets	8
Handshake Packets	11
KM Error Packets	12
ACK Packets	12
Keep-alive Packets	12
NAK Control Packets	13
SHUTDOWN Control Packets	13
ACKACK Control Packets	14
Extended Control Message Packets	14
<b>SRT Data Exchange</b>	<b>15</b>
<b>SRT Data Transmission and Control</b>	<b>16</b>
Buffers	16
Send Buffer Management	16
SRT Buffer Latency	17
SRT Sockets, Send List & Channel	19
Packet Acknowledgement (ACKs)	20
Packet Retransmission (NAKs)	21
Packet Acknowledgment in SRT	22
Bidirectional Transmission Queues	24
ACKs, ACKACKs & Round Trip Time	25
Drift Management	26
Loss List	27
<b>SRT Packet Pacing</b>	<b>29</b>
Packet Probes	34
<b>The Sender's Algorithm</b>	<b>35</b>
<b>The Receiver's Algorithm</b>	<b>35</b>
<b>Loss Information Compression Scheme</b>	<b>35</b>
<b>UDP Multiplexer</b>	<b>35</b>
<b>Timers</b>	<b>35</b>
<b>Flow Control</b>	<b>35</b>

<b>Configurable Congestion Control (CCC)</b>	<b>36</b>
CCC Interface	36
Native Control Algorithm	36
<b>SRT Encryption</b>	<b>37</b>
Overview	37
Definitions	41
Encryption Process Walkthrough	44
Messages	48
Parameters	52
Security Issues	53
Implementation Notes	54
<b>SRT Handshake</b>	<b>56</b>
Overview	56
Handshake Structure	57
The “Legacy” and “SRT Extended” Handshakes	59
The Caller-Listener Handshake	62
The Rendezvous Handshake	64
The SRT Extended Handshake	71
SRT Extension Commands	74
SRT Congestion Control	80
Stream ID (SID)	80
<b>Sample Implementation — HSv4 (Legacy) Caller/Listener Handshake with SRT Extensions</b>	<b>81</b>
<b>Terminology</b>	<b>85</b>
<b>References</b>	<b>87</b>
SRT Alliance	87
SRT on GitHub	87
UDT	87
Encryption	88

## Adaptation of UDT4 to SRT

UDT is an ARQ (Automatic Repeat reQuest) protocol. It implements the third evolution of ARQ (Selective Repeat). The UDT version 4 (UDT4) implementation was proposed as “informational” to the IETF but remained a draft (draft-gg-udt-03).

UDT is aimed at the maximum use of capacity, so an application must ensure input buffers are always available when it is time to send data. When sending real-time video at a reasonable bit rate, the speed of packet generation is slow compared to reading a file. Buffer depletion causes some resets in the UDT transmission algorithm. Also, when congestion occurred the sender algorithm could block the UDT API, preferring to transmit the packets in the loss list, so that new video frames could not be processed. Real-time video cannot be suspended, so packets would be dropped by the application (since the transmission API was being blocked). Unlike UDT, SRT shares the available bandwidth between real-time and retransmitted packets, losing or dropping older packets instead of newer.

The initial development of SRT involved a number of changes and additions to UDT version 4, primarily:

- Statistics counters in bytes
- Buffer sizes in milliseconds to control Latency (measuring buffers in time units is easier for configuring latency, and is independent of stream bitrate)
- Statistics in ACK messages (receive rate and estimated link capacity)
- Control packet timestamps (this is in the UDT draft but not in the UDT4 implementation)
- Timestamp drift correction algorithm
- Periodic NAK reports (UDT4 disabled this draft feature in favor of timeout retransmission of unACKed packets, which consumes too much bandwidth for real-time streaming applications).
- Timestamp-Based Packet Delivery (configured latency)
- SRT handshake based on UDT user-defined control packet for exchanging peer configuration and implementation information to ensure seamless upgrades while evolving the protocol, and to maintain backward compatibility
- Maximum output rate based on configured value or measured input rate
- Encryption:
  - Keying material generation from a passphrase
  - Exchange of keying material and decryption status using a UDT user-defined control packet (sender knows if a receiver can properly decrypt stream)
  - AES-CTR encryption/decryption: reassign 2 bits in the data header’s message number to specify the key (odd/even/none) used for encryption; similar to the DVB scrambling control field

- Ensure smooth key regeneration after CTR exhaustion

Early development of SRT was conducted using hardware encoders and decoders (Makito X series from Haivision) on internal networks, where randomly distributed packet drops were simulated using the *netem* utility<sup>1</sup>.

In the presence of moderate packet loss the decoder experienced buffer depletion (no packets to decode). Lost packets were not retransmitted in time. The fix for that was to trigger the unacknowledged packet retransmission (the Auto Repeat of ARQ) earlier. However, this caused a surge in bandwidth usage. Retransmission upon timeout is done when packets are not acknowledged quickly enough. In UDT4, this retransmission occurs only when the loss list is empty.

Retransmitting all the packets for which an ACK was past due (sent more than RTT ms ago) resolved the test scenario since there was no congestion and the random packet drop would affect different packets. After many retransmissions, all packets would be delivered and the receiver's queue unblocked. This was at the cost of huge bandwidth usage since at the time there was no sending rate control.

---

<sup>1</sup> It was later discovered that this model is not a good simulation as packets are dropped without any network congestion. Packet loss was simulated in both directions, which means some feedback control packets were also dropped.

## Packet Structure

SRT maintains UDT's UDP packet structure, but with some modifications. Refer to Section 2 of the UDT IETF Internet Draft (draft-gg-udt-03.txt) for more details.

### Data and Control Packets

Every UDP packet carrying SRT traffic contains an SRT header (immediately after the UDP header). In all versions, the SRT header contains four major 32-bit fields:

- PH\_SEQNO
- PH\_MSGNO
- PH\_TIMESTAMP
- PH\_ID

SRT has two kinds of packets, where the first bit in the PH\_SEQNO field in the packet header distinguishes between data (0) and control (1) packets. Below, for example, is a representation of an SRT **data** packet header (where the "packet type" bit = 0):

**NOTE:** Changes in the packet structure were introduced in SRT version 1.3.0. For the purpose of promoting compatibility with earlier versions, old and new packet structures are presented here. Packet diagrams in this document are in network bit order (big-endian).

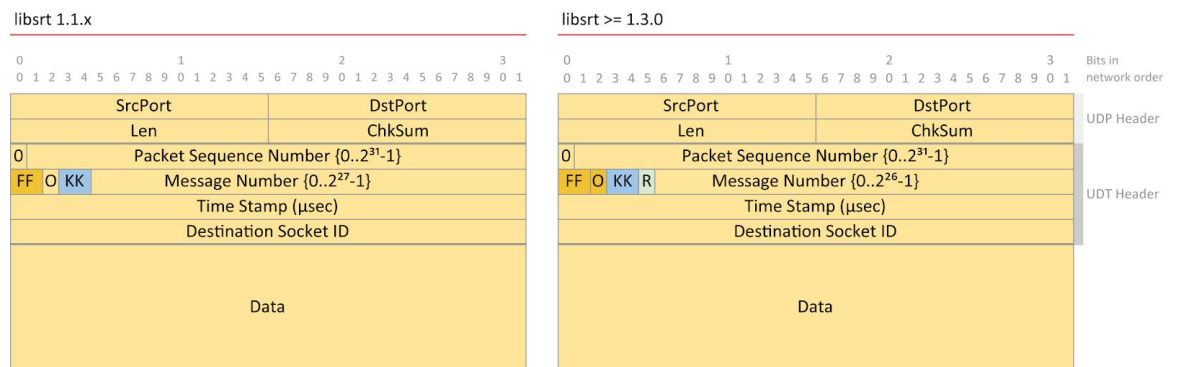

### LEGEND



- **FF** = (2 bits) Position of packet in message, where:
  - 10b = 1st
  - 00b = middle
  - 01b = last
  - 11b = single
- **O** = (1 bit) Indicates whether the message should be delivered in order (1) or not (0). In File/Message mode (original UDT with UDT\_DGRAM) when this bit is clear then a message that is sent later (but reassembled before an earlier message which may be incomplete due to packet loss) is allowed to be delivered immediately, without waiting

for the earlier message to be completed. This is not used in Live mode because there’s a completely different function used for data extraction when TSBPD mode is on.

- **KK** = (2 bits) Indicates whether or not data is encrypted:
  - 00b: not encrypted
  - 01b: encrypted with even key
  - 10b: encrypted with odd key
- **R** = (1 bit) Retransmitted packet. This flag is clear (0) when a packet is transmitted the very first time, and is set (1) if the packet is retransmitted.

In Data packets, the third and fourth fields are interpreted as follows:

- **TIMESTAMP**: Usually the time when a packet was sent, although the real interpretation may vary depending on the type.
- **ID**: The Destination Socket ID to which a packet should be dispatched, although it may have the special value 0 when the packet is a connection request

Additional details for Data packets are discussed later in this document.

An SRT **control** packet header (“packet type” bit = 1) has the following structure (UDP header not shown):

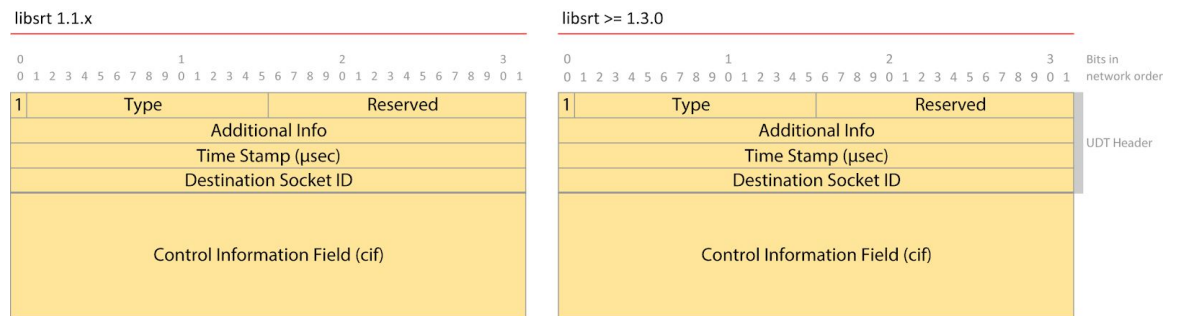

For Control packets the first two fields are interpreted respectively (using network bit order) as:

- **Word 0**:
  - Bit 0: packet type (set to 1 for control packet)
  - Bits 1-15: Message Type
  - Bits 16-31: Message Extended type

Type	Extended Type	Description
0	0	HANDSHAKE
1	0	KEEPALIVE
2	0	ACK
3	0	NAK (Loss Report)



4	0	Congestion Warning
5	0	Shutdown
6	0	ACKACK
7	0	Drop Request
8	0	Peer Error
0x7FFF	-	Message Extension
0x7FFF	1	SRT_HSREQ: SRT Handshake Request
0x7FFF	2	SRT_HSRSP: SRT Handshake Response
0x7FFF	3	SRT_KMREQ: Encryption Keying Material Request
0x7FFF	4	SRT_KMRSP: Encryption Keying Material Response

The Extended Message mechanism is theoretically open for further extensions. SRT uses some of them for its own purposes. This will be referred to later in the section on the SRT Extended Handshake.

- Word 1:
  - Additional info — used in some control messages as extra space for data. Its interpretation depends on the particular message type. Handshake messages don't use it.

## Handshake Packets

Handshake control packets (“packet type” bit = 1) are used to establish a connection between two peers in a point-to-point SRT session. Original versions of SRT relied on handshake extensions to exchange certain parameters immediately after a connection was opened, but as of version 1.3 an integrated mechanism ensures all parameters are exchanged as part of the handshake itself. Refer to the **Handshake** section later in this document for details.

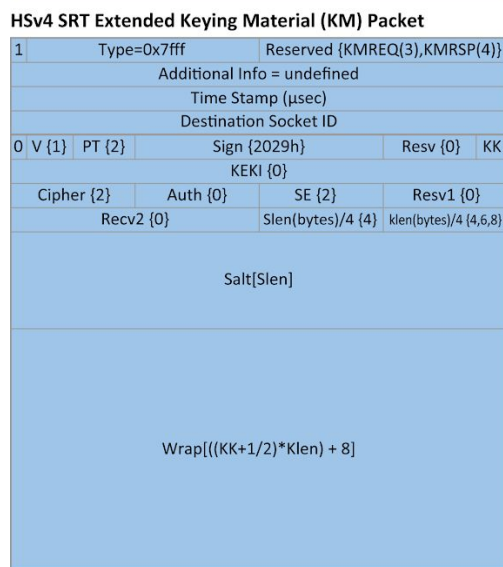
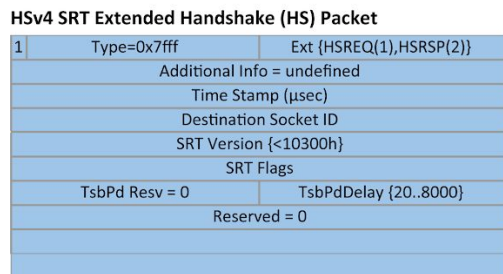
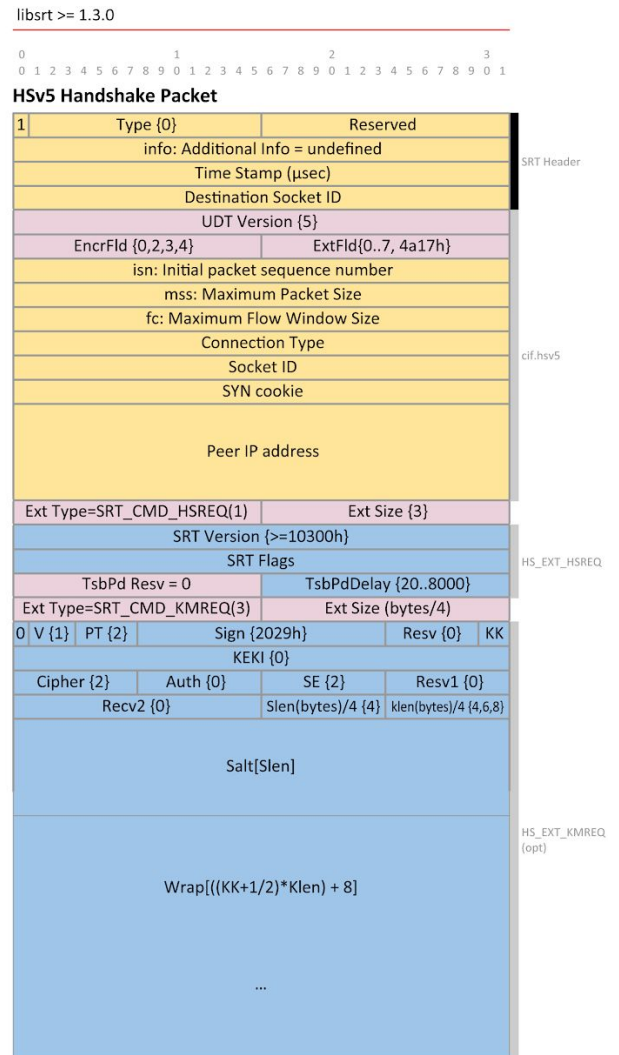
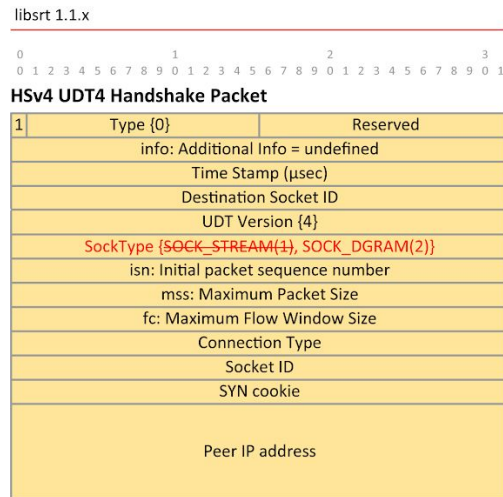

## KM Error Response Packets

Key Message Error Response control packets (“packet type” bit = 1) are used to exchange error status messages between peers. Refer to the **Encryption** section later in this document for details.

libsrt 1.1.x

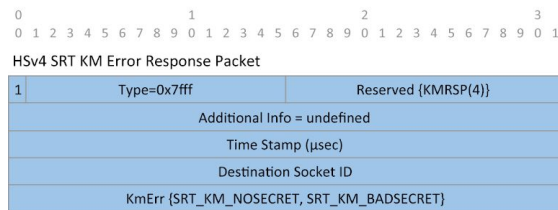

libsrt >= 1.3.0

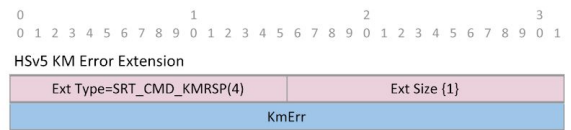

## ACK Packets

Acknowledgement (ACK) control packets (“packet type” bit = 1) are used to provide data packet delivery status and RTT information. Refer to the **SRT Data Transmission and Control** section later in this document for details.

libsrt 1.1.x

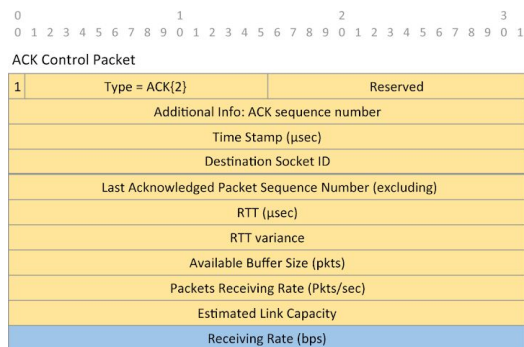

libsrt >= 1.3.0

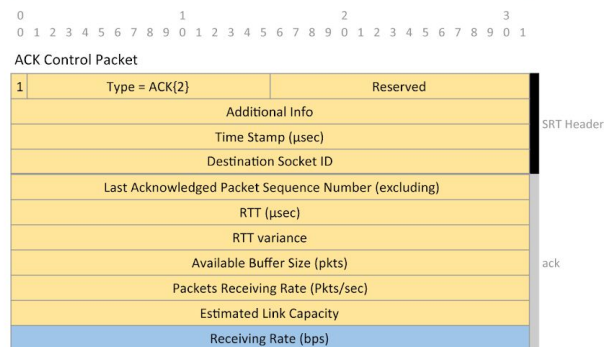

## Keep-alive Packets

Keep-alive control packets (“packet type” bit = 1) are exchanged approximately every 10 ms to enable SRT streams to be automatically restored after a connection loss.

libsrt 1.1.x

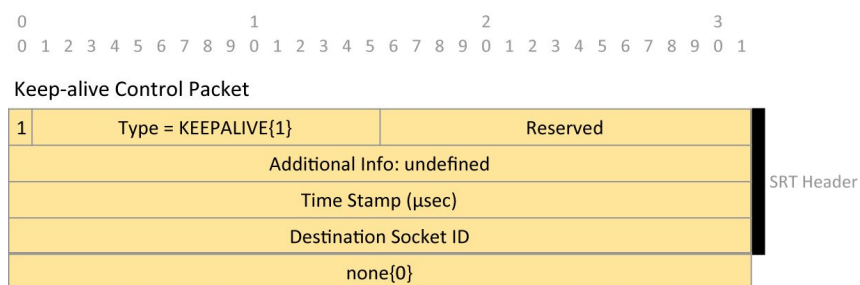

### NAK Control Packets

Negative acknowledgement (NAK) control packets (“packet type” bit = 1) are used to signal failed data packet deliveries. Refer to the **SRT Data Transmission and Control** section later in this document for details.

**libsrt 1.1.x**

---

0 1 2 3  
 0 1 2 3 4 5 6 7 8 9 0 1 2 3 4 5 6 7 8 9 0 1 2 3 4 5 6 7 8 9 0 1

**NAK Control Packet**

1	Type = NAK{3}	Reserved	SRT Header
Additional Info: undefined			
Time Stamp (µsec)			
Destination Socket ID			
0	lost packet sequence number=2h		Loss List
1	list of lost packets starting with sequence number=2h		
0	up to (including)=Bh		
0	lost packet sequence number= Eh		

### SHUTDOWN Control Packets

Shutdown control packets (“packet type” bit = 1) are used to initiate the closing of an SRT connection.

**libsrt 1.1.x**

---

0 1 2 3  
 0 1 2 3 4 5 6 7 8 9 0 1 2 3 4 5 6 7 8 9 0 1 2 3 4 5 6 7 8 9 0 1

**SHUTDOWN Control Packet**

1	Type = SHUTDOWN{5}	Reserved	SRT Header
Additional Info: undefined			
Time Stamp (µsec)			
Destination Socket ID			
none{0}			

## ACKACK Control Packets

ACKACK control packets (“packet type” bit = 1) are used to acknowledge the reception of an ACK, and are instrumental in the ongoing calculation of RTT. Refer to the **SRT Data Transmission and Control** section later in this document for details.

### libsrt 1.1.x

```

0                               1                               2                               3
0 1 2 3 4 5 6 7 8 9 0 1 2 3 4 5 6 7 8 9 0 1 2 3 4 5 6 7 8 9 0 1

```

#### ACKACK Control Packet

1	Type = ACKACK{6}	Reserved	SRT Header
Additional Info: ACK sequence number			
Time Stamp (μsec)			
Destination Socket ID			
control information: none[0]			

## Extended Control Message Packets

Extended Control Message packets (“packet type” bit = 1) are repurposed from the original UDT User control packets. They are used in the SRT extended handshake, either through separate messages, or inside the handshake. Note that they are not intended to be used as user extensions.

### libsrt 1.1.x

```

0                               1                               2                               3
0 1 2 3 4 5 6 7 8 9 0 1 2 3 4 5 6 7 8 9 0 1 2 3 4 5 6 7 8 9 0 1

```

#### Extended Control Message Packet

1	Type = USER{7fff}	Reserved	SRT Header
Additional Info: user defined			
Time Stamp (μsec)			
Destination Socket ID			
control information: user defined			

## SRT Data Exchange

The diagram below provides a high level overview of the data exchange (including control data) between two peers in a point-to-point SRT session. Note that the roles of the peers change over the course of a session. For example, the peers may start as Caller and Listener during the handshake, but then become Sender and Receiver for the data transmission portion.

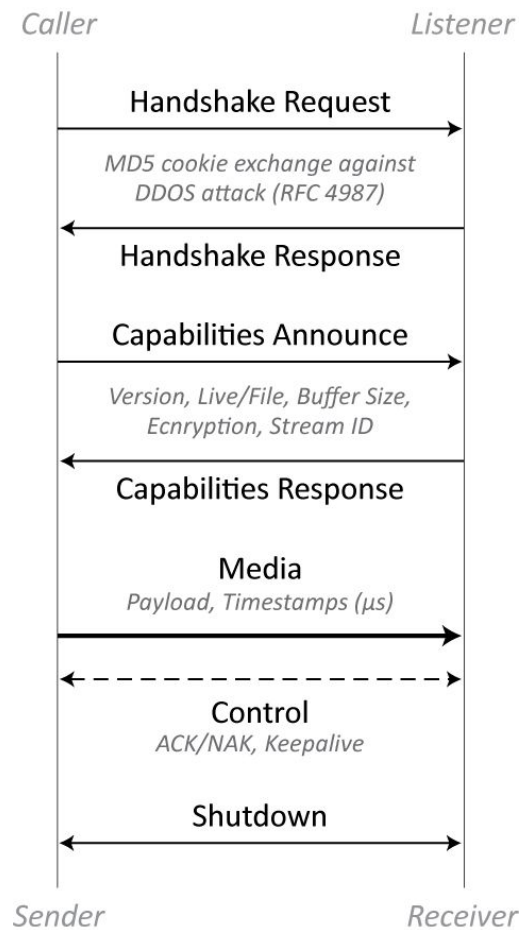

## SRT Data Transmission and Control

This section describes key concepts related to the handling of control and data packets during live streaming of audio and video.

### Buffers

When an application (such as an encoder) provides data packets to SRT for transmission, they are stored in a circular send buffer. They are all numbered with sequence IDs. Packets remain there until they are acknowledged, in case they need to be retransmitted. Each has a timestamp based on the connection time (determined during the handshake, before the first packet is sent).

StartTime is when the application creates an SRT socket. A timestamp is the time between StartTime and when a packet is added to the send buffer.

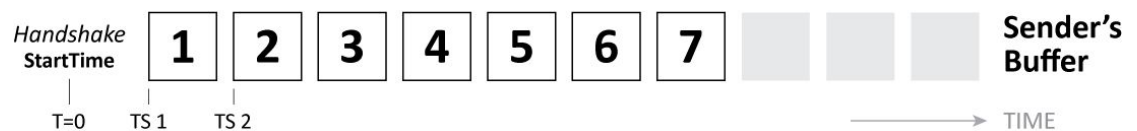

**NOTE:** Time here is shown going from left to right, with the most recent packet at the right.

The receiver has a corresponding buffer. Packets are kept in that queue just until the time that the oldest packet is delivered for output. When the configured latency ends up aligned with packet 2, packet 1 is delivered to the application.

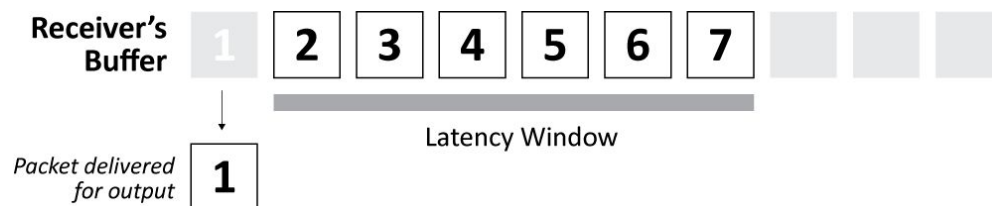

Timestamps are relative to the connection. The transmission is not based on an absolute time. The scheduled execution time is based on a real clock time. A time base is maintained to convert each packet's timestamp to local clock time. Packets are offset from the sender's StartTime. Any time reference based on local StartTime is maintained, taking into account RTT, time zone and drift caused by the sum of truncated nanoseconds and other measurements.

### Send Buffer Management

The send queue (SndQ) is a dynamically sized list that contains references to the contents of the Sender's buffers. When a send buffer has something to send, a reference is added to the SndQ. The SndQ is common to multiple buffers sharing the same channel (UDP socket)<sup>2</sup>.

The diagram below shows a send buffer associated with an SRT socket (CU DT). The SndQ entry contains a reference to the socket, the timestamp, and the location index, which is the location in the SndQ itself. This reference object is part of the SndQ object.

<sup>2</sup> This is the multiplexer: multiple SRT sockets sharing the same UDP socket.

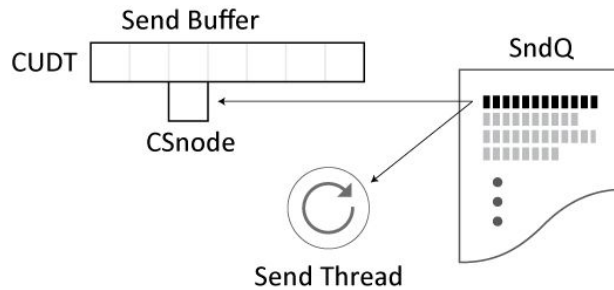

The SndQ is a double link list, where each entry points to the send node (CSnode) of a send buffer. CSnode is an object of the SndQ class (SndQ is a queue, but there are other members in the class). CSnode is not related to the buffer contents. It has a pointer to its socket, timestamp and a location (where it was inserted in the SndQ).

The SndQ has a send thread that looks to see if there is a packet to send. Based on the data contained within the entries, it determines which socket has the packet ready to be sent. It checks the timestamp reference to see if the packet is indeed ready to send. If not, it leaves it in the list. If it is ready, the thread removes it from the list.

Every time the send thread sends a packet, it reinserts it in the list. It then asks for the next packet in the send buffer. That packet's timestamp determines where it will be reinserted in the SndQ, which is sorted in order of timestamps.

Control packets are sent directly. They don't pass through the send buffers or the SndQ. The SndQ updates variables for tracking where packets are added (ACKPOS), and which was the last to be acknowledged (LASTPOS).

### SRT Buffer Latency

The sender and receiver have large buffers that are defined in SRT code (not exposed). On the sender, latency is the time that SRT holds a packet to give it a chance to be delivered successfully while maintaining the rate of the sender at the receiver. The effect of latency is minimal on the sender, where it is used in the context of dropping packets if an ACK is missing or late. It's much clearer on the receiver side.

Latency is a value specified in milliseconds, which can cover hundreds or even thousands of packets at high bitrate. Latency can be thought of as a window that slides over time, during which a number of activities take place.

For example, in the diagram below, packet #2 is the oldest, and is at the head of the receiver's queue (packet #1 has already been delivered).

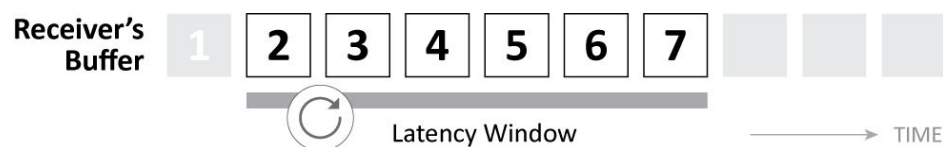

The latency "window" slides from left to right along the queue. When packet #2 slides out of that window, it is delivered to the application on the receiver (e.g. decoder).



Consider a receiver buffer that is storing a series of packets. Let's say we have defined the latency to cover a period equivalent to the transmission of six packets. This latency can be thought of as a window six packets long that slides as time advances.

The ability to recover packets within that latency window depends on the time between transmissions. The latency window effectively defines what is recoverable, or how many times a packet can be recovered, based on the RTT.

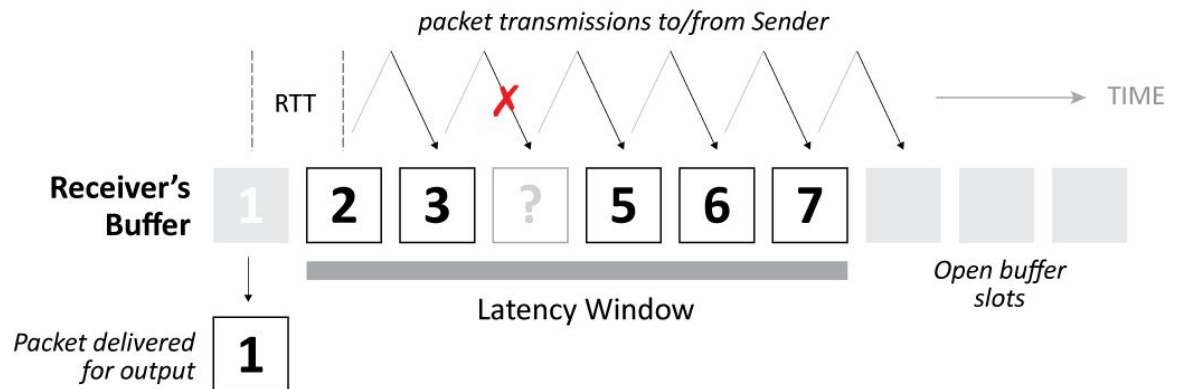

At the appropriate moment, the receiver's buffer releases the first packet to the output application. When the latency window slides to cover the next packet interval, the receiver's buffer releases the second packet to the application, and so on.

Now let's see what happens when a packet is not received (packet #4 in this example). As the latency window slides, that packet is supposed to be ready to give to the application, but is not available. That leads to a skipped packet. It cannot be recovered, so it will be removed from the loss list and never asked for again.

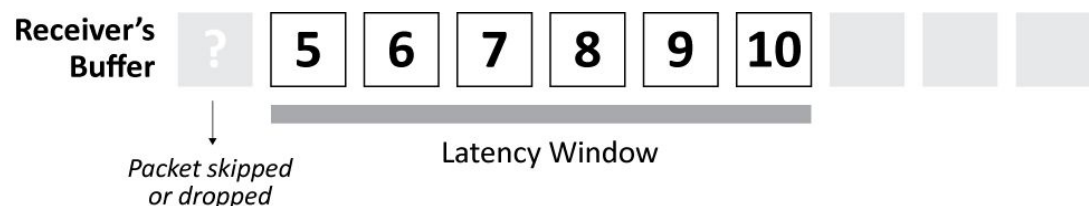

The sliding latency window can be thought of as a zone in which an SRT receiver can recover (most) packets.

On the other side, the sender's buffer also has a latency window. As time advances, the oldest packets that fall outside of the latency window are no longer recoverable — even if they are sent, they will arrive too late to be successfully processed by the receiver.

If the sliding latency window has moved past packets that have not yet been delivered (receipt has not been ACKnowledged), it's too late to send them. They would be outside the delivery window on the receiver — even if they arrive at this point, they would be dropped. So these packets can be removed from the send buffer.

It is important that both sender and receiver have the same latency value to coordinate the timely arrival (or dropping) of packets. In earlier versions of SRT, the sender would propose its latency to the receiver in the handshake. If the latency configured on the receiver was larger, it

would put that value in a packet and send a response. As of SRT 1.3.x both sides can be configured at once in the handshake (no response step necessary).

A packet that falls out of the sender's latency window as it slides over time is one that had already been sent but never acknowledged. It was in the sender's buffer latency window, but the ACKPOS has not advanced (the ACKPOS points to the next packet after the last one that has been confirmed to have been received). When the latency window advances and the oldest packet falls outside the window, it can then be removed. A cleanup of the SndQ will artificially move the ACKPOS to the next packet inside the latency window.

All of the packets in the send buffer have reserved positions, with a configured length (7 cells of 188 plus overhead = 1316, plus a header)<sup>3</sup>. There are actually many send buffers, each containing contiguous packets in order. A send buffer is a circular queue, where the beginning and end can be at any given points, but can never meet. The protocol keeps the sequence (based on ACKs). During transmission the sequence numbers in the packets can reach much higher levels than the actual buffer locations. The sender's buffer works with positions. An item in a buffer has a start position (STARTPOS). There is a conversion between the position in the send buffer and the sequence number as the two increase.

### SRT Sockets, Send List & Channel

Consider sockets 1 and 2, each with its own send buffer. The SndQ contains a list of packets to send. There is a thread that continually checks the send buffer. When a packet is ready to send, a CSnode is created that identifies the packet's socket, and a corresponding object is created in the SndQ that will point back to the send buffer.

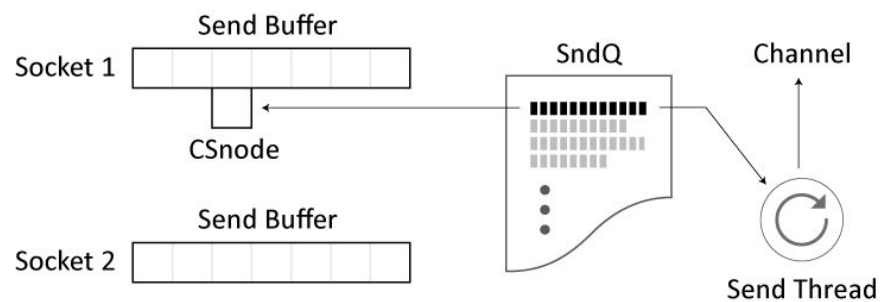

Each packet has a timestamp that dictates when to send it. The SndQ List is sorted in order of the timestamps to be processed. If the send thread determines that the socket 1 send buffer has a packet ready, then it adds it to the SndQ queue. If the SndQ queue is empty, the packet entry is placed at the beginning, with its timestamp, which determines when the packet needs to be processed.

The other send buffer from socket 2 can also add to this SndQ. The send thread will ask the buffer to give it a packet, and it will calculate the spacing between the packets in terms of the rate.

<sup>3</sup> The most common Ethernet MTU is 1500. Assigning 4 bytes for VLANs leaves 1496. One MPEG cell = 188, and 7 TS cells is the maximum that fits within 1500 allowing for protocol headers (1316 + headers = 1360). Note that the UDP output packet size (MTU) for an SRT sender can be set via the API using `SRTQ_MSS`: max segment size, which includes 28+16 bits for the IP/UDP/SRT header.

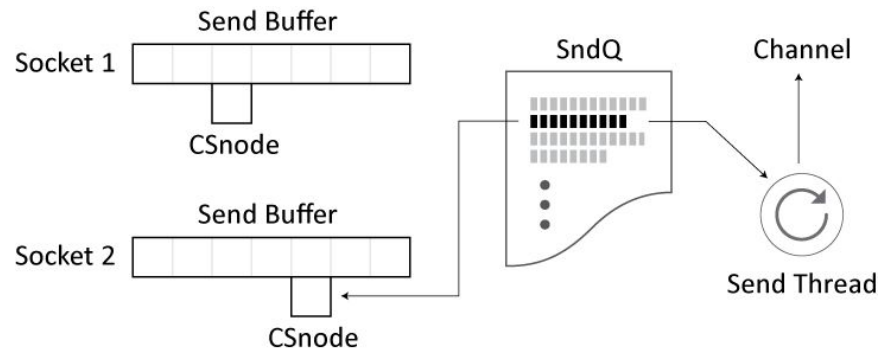

The timestamp together with the inter-packet interval will determine where the packet will be re-inserted in the SndQ (either before or after the packet from the socket 1 buffer).

The SndQ determines from which SRT socket send buffer to take the next packet. The send buffers are tied to the sockets, while the SndQ is more related to the channel. Several sockets can send to the same destination, so they can be multiplexed.

When a packet is added to the socket, the SndQ is updated. And when a packet is ready to be sent, it is re-inserted in the SndQ in the proper position, based on its timestamp.

The processing happens in the SndQ. For each packet, there is a thread that looks to see if it's time to send. If not, it does nothing. Otherwise, it requests the SRT socket to give it the packet to send to the channel. The entries in the SndQ are just references to the SRT socket.

When a packet is written to the send buffer, it gets added to the SndQ, which verifies with CSnode to make sure it does not make a duplicate entry. It repeatedly removes entries and inserts new ones in the appropriate places.

The timestamps for packets in different SRT sockets are local and are defined as the time for sending compared to the current time. At the moment that a packet is added to the SndQ, its timestamp is compared to the current time to determine its position.

The operations of the send buffer and SndQ are decoupled. Packets are added to the buffer, and then the SndQ is informed there is something to send. Each has its own behavior.

The contents of the send buffer are added to the application thread (the sender). Then there is another thread that interacts with the SndQ, which is responsible for controlling the packet spacing with respect to the input rate to the buffer. The output is adjusted by spacing the packets in the buffer.

### Packet Acknowledgement (ACKs)

At certain intervals (see **ACKs, ACKACKs & Round Trip Time**), the receiver sends an ACK that causes the acknowledged packets to be removed from the sender's buffer, at which point the buffer space will be recycled. An ACK contains the sequence number of the packet immediately following the latest of the previous packets that have been received. Where no packet loss has occurred this would be ACK(n+1).

For example, if the receiver sends an ACK for packet 6 (see below), this means that all the packets with sequence numbers less than that have been received, and can be removed from the sender's buffer.

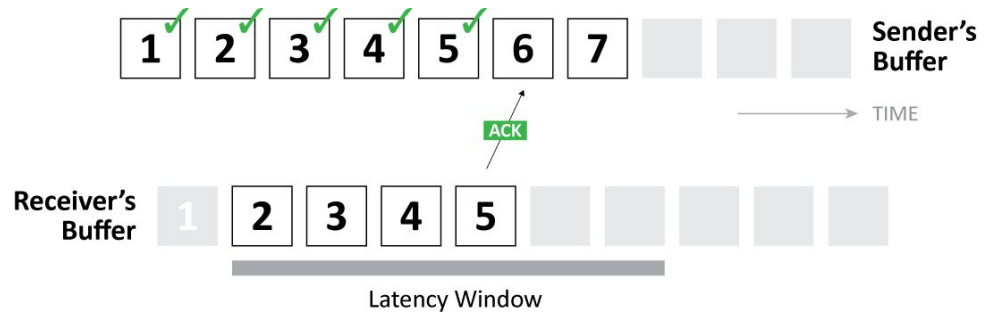

In the case of loss, the ACK(seq) is the sequence number of the first packet in the loss list, which is the last contiguous received packet plus 1.

### Packet Retransmission (NAKs)

If packet #4 arrives in the receiver's buffer, but not packet #3, a NAK is sent to the sender. This NAK is added to a compressed list (the periodic NAK report) that is sent at intervals to mitigate the possibility that individual NAKs may themselves be delayed or lost in transmission.

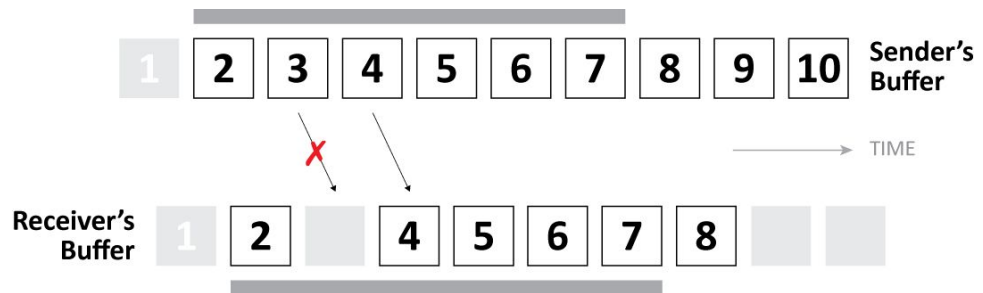

If packet number #2 arrives, but packet #3 does not, then when packet #4 arrives, the NAK is sent right away<sup>4</sup> to address the reordering.

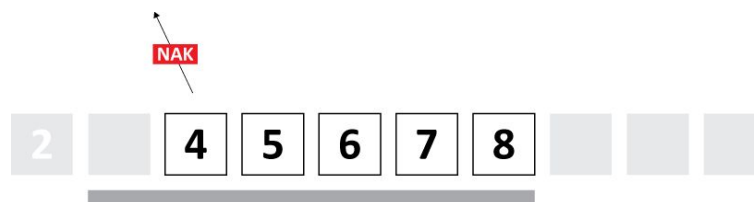

<sup>4</sup> Attempts were made to try to detect and hold back the NAK a little bit to see if the packet would arrive afterwards. If packet 3 arrived just after packet 4, the NAK would be canceled. But this would cause the receiver to hold back certain packets but continue to send the others, putting the packets out of order. Choosing a specific packet and then changing the order in which it is expected to arrive introduces a type of jitter.

## Packet Acknowledgment in SRT

The UDT draft defines a periodic NAK control packet carrying a list of all missing packets. The UDT4 implementation disabled this feature with a comment in favor of retransmission upon timeout. A NAK is sent only once for a missing packet when it is detected (i.e. when the following packet is received). If this NAK is lost, the ACK will block at this packet and prevent the delivery of more packets to the receiving application until the loss list is cleared. On the sender side, the missing packet would not be added to the loss list since the NAK was never received, and NAKs for more recent packets lost after this one prevented the retransmission of unACKed packets.

This implementation choice in UDT of dealing with congestion by blocking retransmissions until the loss list is emptied is fundamentally wrong, since retransmitting the loss list packets first would most probably not unblock the receiver.

Subsequent modifications in SRT (e.g. Periodic NAK Reports, Timestamp-based Packet Delivery, and Too-Late-Packet-Drop, etc.) reduced the occurrences of ACK-timeout retransmissions.

### **Timestamp-based Packet Delivery (TsbPD)**

This feature uses the timestamp of the UDT packet header. The initial intent of the SRT TsbPD design was to reproduce the output of the encoding engine at the input of the decoding engine. This design was imagined in the absence of a transmission ceiling since the faster a packet is transmitted, the faster missing packets will be retransmitted, permitting a lower latency. But the SRT prototype was bandwidth hungry in the presence of bad network conditions, and could hog the network without limits.

Another problem with the original SRT TsbPd design is that it was CPU-bound. The timestamps in the TS packets were based on the speed at which a system could generate and stamp the packets. If the receiver did not have the same CPU capacity, it could not reproduce the pattern of the sender.

In current versions of SRT, TsbPD allows a receiver to deliver packets to the decoder at the same pace they were provided to the SRT sender by an encoder. Basically, the sender timestamp in the received packet is adjusted to the receiver's local time (compensating for time drift or different time zone) before releasing the packet to the application. Packets can be withheld by SRT for a configured receiver delay (mSec). Higher delay can accommodate a larger uniform packet drop rate or larger packet burst drop. Packets received after their "play time" are dropped.

The packet timestamp (in microseconds) is relative to the SRT connection creation time. The original UDT code uses the packet sending time to stamp the packet. This is inappropriate for the TsbPD feature since a new time (current sending time) is used for retransmitted packets, putting them out of order when inserted at their proper place in the stream. Packets are inserted based on the sequence number in the header field.

The origin time (in microseconds) of the packet is already sampled when a packet is first submitted by the application to the SRT sender. The TsbPD feature uses this time to stamp the

packet for first transmission and any subsequent re-transmission. This timestamp<sup>5</sup> and the configured latency control the recovery buffer size and the instant that packets are delivered at the destination.

The UDT protocol does not use the packet timestamp, so this change has no impact on that protocol or its existing congestion control methods.

### Fast Retransmit

The UDT4 native retransmission of unacknowledged packets on timeout does not work well for real-time data. Unacknowledged data is not retransmitted as long as there are packets in the loss list. With uniform distribution of packet loss, there is often something in the loss list when the retransmission timer expires, starting a cascade of events disrupting the flow of real time data (congestion window, sender buffer full, packet dropped, etc.).

The Fast Retransmit feature addresses the issue by retransmitting unacknowledged packets before the congestion window is full. The sender adds to the loss list any packets that have not been ACKed within a reasonable time, based on the RTT and the original timestamp of the dropped packet.

Fast Retransmit reduces the receiver buffer size, and therefore latency. It also makes any loss packet counter variations smoother compared to re-retransmission when the congestion window is full. It is, however, very bandwidth hungry. This SRT sender feature is kept for interoperability with SRT 1.0 receivers. When the *Periodic NAK Reports* feature is active, it rarely triggers and is kept as a watchdog.

### Periodic NAK Reports

SRT 1.0 was not efficient at recovering packet loss above 2%. Many packets were being retransmitted by the sender, often more than once, without knowing if these packets were really lost. There are conditions where the maximum overhead bandwidth and latency could not sustain the loss rate.

Periodic NAK Reports are disabled in the UDT4 native code. The feature was revived in the SRT 1.1.0 receiver, improving the functionality of SRT in high loss environments, and the performance in all loss conditions. The implementation requires about twice the loss rate for retransmission bandwidth overhead. Recovery of up to 10% packet loss within the limits of SRT configuration parameters can be achieved.

SRT Periodic NAK reports are sent with a period of  $RTT/2$ , with a 20 msec floor (the UDT4 setting was 300 msec). A NAK control packet contains a compressed list of the lost packets. Therefore, only lost packets are retransmitted. By using  $RTT/2$  for the NAK reports period, it may happen that lost packets are retransmitted more than once, but it helps maintain low latency in the case where NAK packets are lost.

### Too-Late-Packet-Drop

This feature, introduced with SRT 1.0.5, allows the sender to drop packets that have no chance to be delivered in time. In the SRT sender, when Too-Late Packet Drop is enabled, and a packet

---

<sup>5</sup> Timestamps also help measure recovery buffers in time duration instead of bytes or packets. Time-based stats are more easily understandable by operators and independent of content bit rate.

timestamp is older than 125% of the SRT latency, it is considered too late to be delivered and may be dropped by the encoder. Packets of an IFrame tail can then be dropped before being delivered.

Recent receivers (SRT >= 1.1.0) will prevent buggy senders (<= 1.0.7) from enabling packet drop on the sender side. Recent senders (SRT >= 1.1.0) keep packets at least 1000 ms if SRT latency is lower than 1000 msec (not enough for large RTT).

In the receiver, tail packets of a big I-Frame may be quite late and not held by the SRT receive buffer. They pass through to the application. The receiver buffer depletes and there is no time left for retransmission if missing packets are discovered. Missing packets are then skipped by the receiver.

### Bidirectional Transmission Queues

SRT also anticipates the case where the receiver has its own transmission queue, and the sender has a corresponding receiver queue for bidirectional communication.

It's useful to think of this as a standard point-to-point SRT session between Sender and Receiver, where each peer has a transmit/send (Tx) buffer as well as a receive (Rx) buffer. The Sender's Tx communicates with the Receiver's Rx, while the Receiver's Tx communicates with the Sender's Rx. Just as in a regular one-way session, the Tx/Rx latency values must match.

In the handshake packet, the sender will provide both its preferred Tx latency and a suggested "peer latency" (the value for the Receiver's Tx). The Receiver responds with corresponding values. The proposed latency values are evaluated on both sides (and the larger values chosen) within a single RTT period.

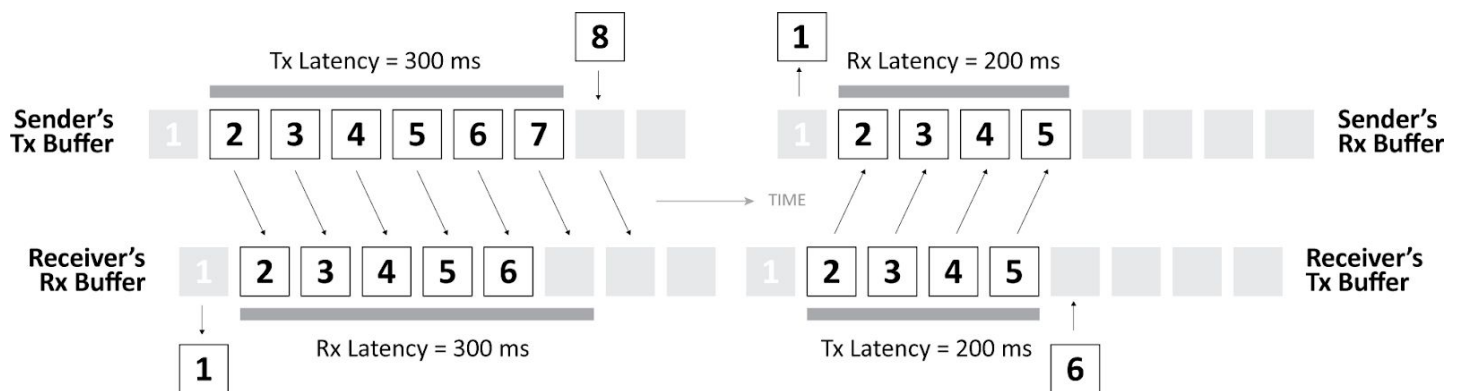

### ACKs, ACKACKs & Round Trip Time

Round-trip time (RTT) is a measure of the time it would take for a packet to travel back and forth. SRT cannot measure one-way transmission time directly, so it uses  $RTT/2$ , which is calculated based on an ACK. An ACK (from a receiver) will trigger the transmission of an ACKACK (by the sender), with almost no delay. The time it takes for an ACK to be sent and an ACKACK to be received is the RTT.

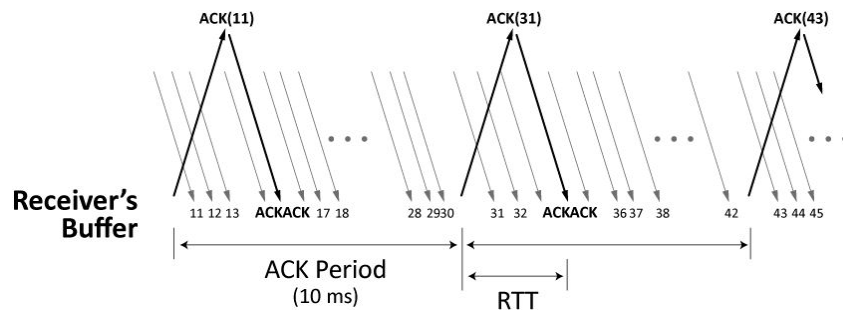

The ACKACK tells the receiver to stop sending the ACK position because the sender already knows it. Otherwise, ACKs (with outdated information) would continue to be sent regularly. Similarly, if the sender doesn't receive an ACK, it doesn't stop transmitting.

There are two conditions<sup>6</sup> for sending an acknowledgement. A full ACK is based on a timer of 10 ms (the ACK period). For high bit rate transmissions, a "light ACK"<sup>7</sup> can be sent, which is an ACK for a sequence of packets. In a 10 ms interval, there are often so many packets being sent and received that the ACK position on the sender doesn't advance quickly enough. To mitigate this, after 64 packets (even if the ACK period has not fully elapsed) the receiver sends a light ACK.

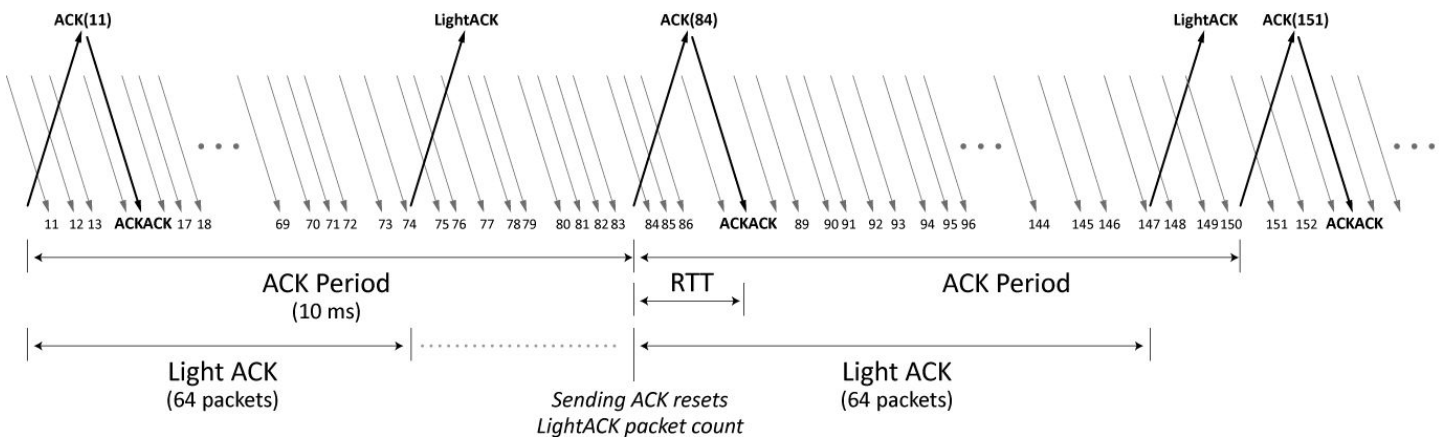

An ACK serves as a ping, with a corresponding ACKACK pong, to measure RTT. Each ACK has a number. A corresponding ACKACK has that same number. The receiver keeps a list of all ACKs in a queue to match them. Unlike a full ACK, which contains the current RTT and several other values in the control information field (CIF), a light ACK just contains the sequence number (see diagrams below). All control messages are sent directly and processed upon reception, but ACKACK processing time is negligible (the time this takes is included in the round-trip time).

<sup>6</sup> ACKinterval (pkts) and ACKperiod (ms) used to be configurable.

<sup>7</sup> A light ACK is a shorter ACK (header + 1 x 32-bit field). It does not trigger an ACKACK.



The RTT is calculated by the receiver and sent with the next full ACK. Note that the first ACK in an SRT session might contain an initial RTT value of 100 ms, because the early calculations may not be precise.

0	1	2	3	4	5	6	7	8	9	0	1	2	3	4	5	6	7	8	9	0	1	2	3	4	5	6	7	8	9	0	1
1	Type = ACK{2}															Reserved															
info: Additional Info = undefined																															
Time Stamp (μsec)																															
Destination Socket ID																															
Last Acknowledged Packet Sequence Number (excluding)																															
RTT (μsec)																															
RTT variance																															
Available Buffer Size (pkts)																															
Packets Receiving Rate (Pkts/sec)																															
Estimated Link Capacity																															
Receiving Rate (bps)																															
0	1	2	3	4	5	6	7	8	9	0	1	2	3	4	5	6	7	8	9	0	1	2	3	4	5	6	7	8	9	0	1
1	Type = ACKACK{6}															Reserved															
Additional Info: ACK sequence number																															
Time Stamp (μsec)																															
Destination Socket ID																															
control information: none{0}																															

The sender always gets the RTT from the receiver. It does not have an analog to the ACK/ACKACK mechanism (i.e. it can't send a message that guarantees an immediate return without processing).

### Drift Management

When the sender enters “connected” status it tells the application there is a socket interface that is transmitter-ready. At this point the application can start sending data packets. It adds packets to the SRT sender's buffer at a certain input rate, from which they are transmitted to the receiver at scheduled times.

A synchronized time is required to keep proper sender/receiver buffer levels, taking into account the time zone and round-trip time (up to 2 seconds for satellite links). Considering addition/subtraction round-off, and possibly unsynchronized system times, an agreed-upon time base drifts by a few microseconds every minute. The drift may accumulate over many days to a point where the sender or receiver buffers will overflow or deplete, seriously affecting the quality of the video. SRT has a time management mechanism to compensate for this drift.

When a packet is received, SRT determines the difference between the time it was expected and its timestamp. The timestamp is calculated on the receiver side. The RTT tells the receiver how much time it was supposed to take. SRT maintains a reference between the time at the

leading edge of the send buffer's latency window and the corresponding time on the receiver (the present time). This allows conversion to real time to be able to schedule events, based on a local time reference.

The receiver samples time drift data<sup>8</sup> and periodically calculates a packet timestamp correction factor, which is applied to each data packet received by adjusting the inter-packet interval. When a packet is received it isn't given right away to the application. As time advances, the receiver knows the expected time for any missing or dropped packet, and can use this information to fill any "holes" in the receive queue with another packet.

The receiver uses local time to be able to schedule events — to determine, for example, if it's time to deliver a certain packet right away. The timestamps in the packets themselves are just references to the beginning of the session. When a packet is received (with a timestamp from the sender), the receiver makes a reference to the beginning of the session to recalculate its timestamp. The start time is derived from the local time at the moment that the session is connected. A packet timestamp equals "now" minus "StartTime", where the latter is the point in time when the socket was created.

### Loss List

The sender maintains a list of lost packets (loss list) that is built from NAK reports. When scheduling to transmit, it looks to see if a packet in the loss list has priority, and will send it. Otherwise, it will send the next packet in the SndQ list. Note that when a packet is transmitted, it stays in the buffer in case it is not received.

NAK packets are processed to fill the loss list. As the latency window advances and packets are dropped from the send queue, a check is performed to see if any of the dropped or resent packets are in the loss list, to determine if they can be removed from there as well so that they are not retransmitted unnecessarily. The operations in the send queue and the loss list are managed by changing the ACK position (ACKPOS).

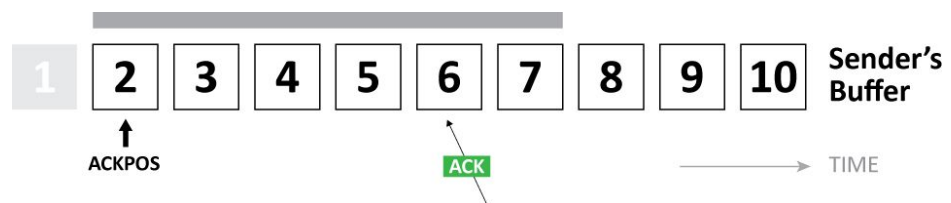

When the ACKPOS has advanced to a certain point, all the packets older than the one at that position are removed from the send queue.

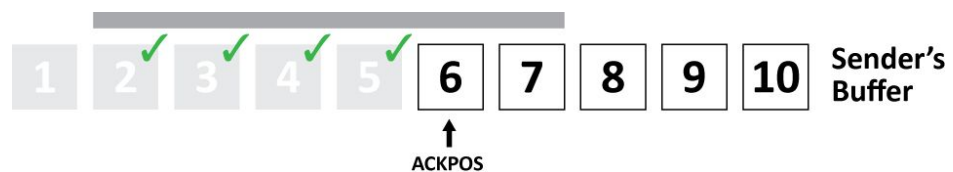

<sup>8</sup> The period is based on a number of packets rather than time duration to ensure enough samples, independently of the media stream packet rate. The effect of network jitter on the estimated time drift is attenuated by using a large number of samples. The time drift being very slow (affecting a stream only after many hours), a fast reaction is not necessary.

When a receiver encounters the situation where the next packet to be played was not successfully received from the sender, it will “skip” this packet and send a fake ACK. To the sender, this fake ACK is a real ACK, and so it just behaves as if the packet had been received. This facilitates the synchronization between sender and receiver. The fact that a packet was skipped remains unknown by the sender. Skipped packets are recorded in the statistics on the receiver.

What the sender sees is the NAKs that it has received. There is a counter for the packets that are resent. If there is no ACK for a packet, it will stay in the loss list and can be resent more than once. Packets in the loss list are prioritized.

If packets in the loss list continue to block the send queue, at some point this will cause the send queue to fill. When the send queue is full, the sender will begin to drop packets without even sending them the first time. An encoder (or other application) may continue to provide packets, but there’s no place for them, so they will end up being thrown away. SRT is unaware of these “unsent packets”, and they are not reported in the SRT statistics.

This condition where packets are unsent doesn’t happen often. There is a maximum number of packets held in the send buffer based on the configured latency. Older packets that have no chance to be retransmitted and played in time are dropped, making room for newer real-time packets produced by the sending application. A minimum of one second is applied before dropping the packet when low latency is configured. This one-second limit derives from the behavior of MPEG I-frames with SRT used as transport. I-frames are very large (typically 8 times larger than other packets), and consequently take more time to transmit. They can be too large to keep in the latency window, and can cause packets to be dropped from the queue. To prevent this, SRT imposes a minimum of one second (or the latency value) before dropping a packet. This allows for large I-frames when using small latency values.

## SRT Packet Pacing

UDT uses a maximum bandwidth setting to control the packet output rate. This static setting isn't well-suited to a variable input, like when you change the bit rate on an encoder. SRT controls packet pacing based on the input rate and an overhead for the retransmission (which is calculated on the output).

Originally, SRT took as input the rate that had been configured as the expected output rate of an encoder (in terms of bit rate for the packets including audio and overhead). But it's normal for an encoder to occasionally overshoot. At low bit rate, sometimes an encoder can be too optimistic and will output more bits than expected. Under these conditions, SRT packets would not go out fast enough because SRT ends up being wrongly configured.

This was mitigated by calculating the bit rate internally. SRT examines the packets being submitted and calculates the bit rate as a moving average. However, this introduces a bit of a delay based on the content. It also means that if an encoder encounters black screens or still frames, this would dramatically lower the bit rate being measured, which would in turn reduce the SRT output rate. And then, when the input from the encoder picks up, SRT would not start up again fast enough on output. Packets would be delayed and would arrive late at the decoder, causing errors.

A proposed solution is to have SRT take the input rate configuration from the encoder, measure the actual input, and use whichever value is larger.

Output is controlled by calculating a packet period (the interval between two packets). For a given bit rate, SRT calculates the average size of a packet. The interval between the packets is determined by comparing the timestamps between consecutive packets. Packet output is scheduled based on the packet size and interval.

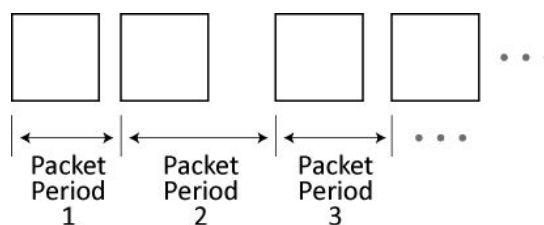

Transmission speed is controlled by a timer between the packets. In the legacy code, the packet period is adjusted by the congestion control module on the sender. Based on feedback from the network, it shrinks to speed up or grows to slow down. But this does not work well for SRT in live mode. The audio/video stream bitrate is embedded in the MPEG-TS packets assembled by the streamer, and modifying the output packet pace will not affect the expected elementary stream rate at the receiving side — it will just break the decoding. What was done originally in SRT was to apply a period such that the output rate resembles the input. By default, SRT measures the bit rate of the input stream, and then it adjusts the packet period accordingly.

SRT needs a certain amount of bandwidth overhead in order to have space to insert retransmitted packets without affecting the SRT sender's main stream output rate too much so that packets can be transmitted normally. The only way to apply the network feedback to

reduce congestion was to control the encoder output bit rate (SRT input). It was not possible to adjust the packets that had already been assembled with an expected bitrate, because the expectation was that they would be output at that rate for the decoder.

There are three configuration elements: INPUTBW, MAXBW, and OVERHEAD (%).

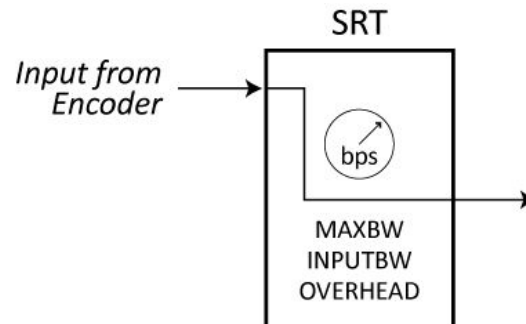

MAXBW	INPUTBW	OVERHEAD (%)	Output Rate <sup>9</sup>
mbw	n/a	n/a	<mbw>
0	0	oh	<smpinpbw> * (100+<oh>)/100
0	ibw	oh	<ibw>*(100+<oh>)/100

Setting the input bandwidth (INPUTBW) parameter to 0 engages internal measurements (smpinpbw) to set the packet period, and to combine it with the overhead setting to adjust the output.

Alternatively, an absolute maximum bandwidth (MAXBW) can be configured to set a cap. Setting MAXBW to zero forces SRT to use only INPUTBW to adjust the output.

There are certain considerations that an SRT integrator should take into account. The problem with using the input bandwidth method (measuring internally) is that there is a lag in the measurement because it is based on a moving average. So if the input rate suddenly falls to zero (for example, because there is a black screen in the video stream), the measured drop results in a lowered output rate. But when the video picks up again, the input rate rises sharply. The output rate from SRT lags slightly behind the input rate from the encoder. Packets accumulate in the SRT sender's buffer, because of the time it takes to measure the speed. If they arrive too late at the output, there is a negative effect.

<sup>9</sup> If you set `SRTO_MAXBW=0` and `SRTO_INPUTBW=0` then the input bitrate will be measured internally and used to adjust the output bitrate to  $\text{measured-input} * (100 + \text{overhead}) / 100$ , overhead being configured with `SRTO_OHEABW` (in %). Note that the units of `SRTO_MAXBW` and `SRTO_INPUTBW` are in bytes/sec.

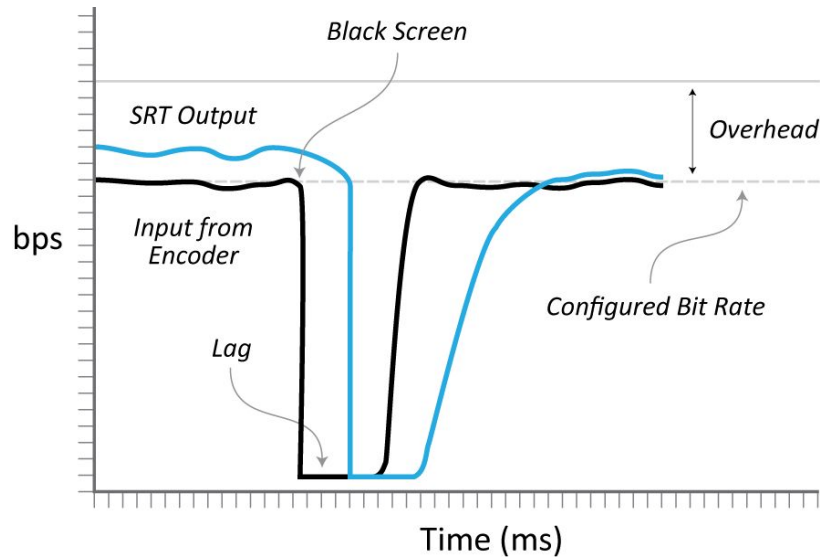

To correct this, the SRT sender’s output can be configured at the nominal bit rate of the input by interacting more directly with the video encoder on which SRT is running. Since it is possible to know the bit rate at which the encoder is configured, any modification can be passed directly into the SRT configuration (INPUTBW). This is the goal.

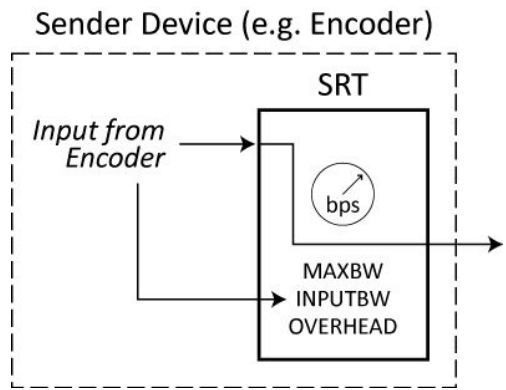

In the diagram below, the SRT sender’s output starts to follow the dip in encoder input caused by the black screen, but will not follow all the way.

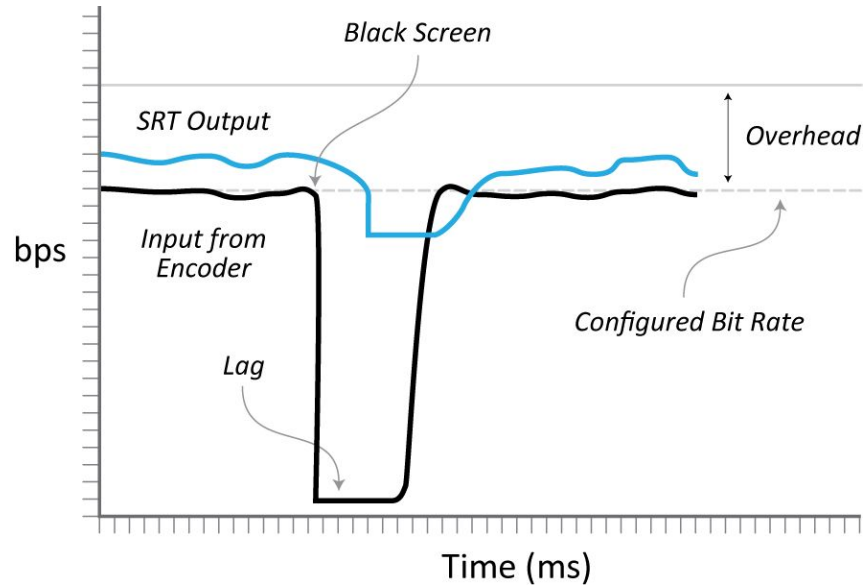

But this solution has its own weaknesses. At low bit rate, the input to SRT from an encoder will often exceed the nominal bit rate. Since the SRT sender's output is being adjusted based on the configured encoder bitrate, input that is too high causes an accumulation of packets in the send buffer. The buffer can fill up faster than packets are being sent out. The SRT output would be at the right speed, but these accumulated packets would have to be transmitted over an extended period of time. They would accumulate in the buffer, wouldn't be output quickly enough, and eventually some packets would be sent too late.

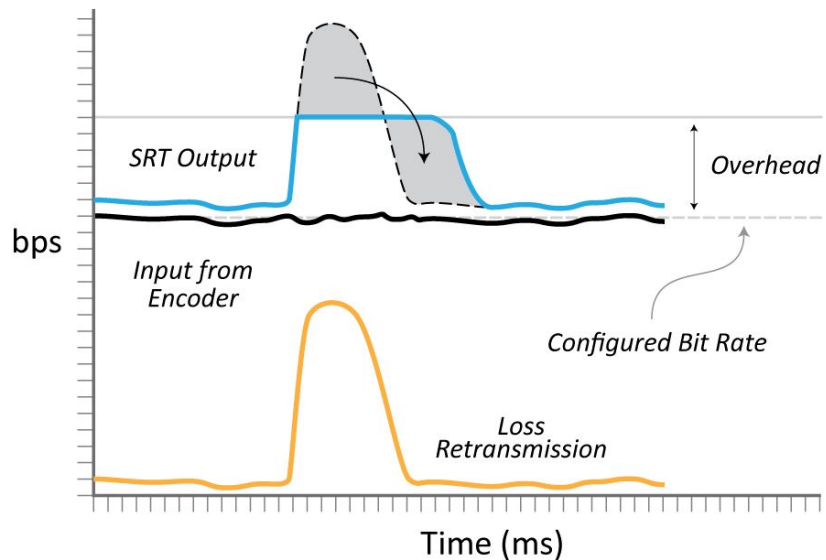

The orange line in graphs above represents packets that have to be retransmitted using the available overhead space, based on the latency. The area under the orange line represents the volume of packets that were lost. These have to be added on top of the regular flow, the real-time live stream, which has to be maintained at all times.

In principle, the space between packets determines where retransmissions can be inserted, and the overhead represents the available margin. There is an empiric calculation that defines the interval (in microseconds) between two packets to give a certain bit rate. It's a function of the payload (which includes video, audio etc.).

SRT tries to re-create the sender's input bandwidth on the decoder's output, such that the act of retransmitting packets is transparent, as if they never had to be resent in the first place. This works up to a point, but as soon as the packet pacing goes down, there's an accumulation that happens in the send buffer. It becomes increasingly full, and doesn't empty fast enough, until at some point packets start dropping.

SRT version 1.3 combines the two packet pacing methods. The input is measured, but if it falls too low, the nominal input bit rate value for the SRT sender's output is respected. If a measurement is lower than the nominal configuration, it isn't followed (if there are no packets to send SRT doesn't send anything). However, if the encoder input rate rises above the configured rate, it will be followed as much as possible. Combining the two methods overcomes the deficiencies of each.

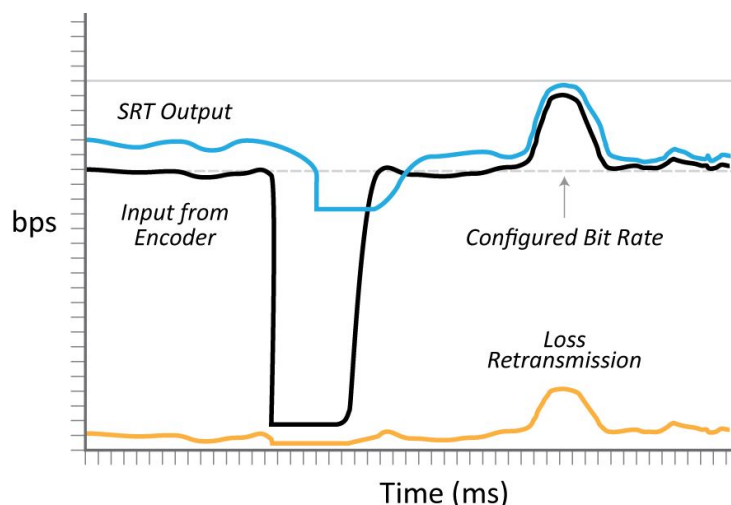

In theory, the bandwidth cap is accounted for by the bandwidth overhead. If there are too many packets to retransmit, SRT does not transmit them. But this mechanism of capping the bandwidth doesn't work too well. The bandwidth limit is broken too easily.

Another change made in SRT version 1.3 was to add a configuration option called `OUTPACEMODE`, which enables combinations of the other pacing elements. Recall that `MAXBW` is the mode with an absolute cap that doesn't follow the fluctuations in the encoder input. Each time the input bit rate is configured on the encoder, `MAXBW` must also be reconfigured. Setting `MAXBW` to zero means use `INPUTBW`. Conversely, setting `INPUTBW` to zero means measure internally.

SRT version 1.3 uses a combination of techniques to take the configured input, compare against the measured value, and use the maximum of the two. `OUTPACEMODE` is used to enable



combinations of these other configuration elements. It specifies the use of MAXBW, or of INPUTBW, a combination of the two, or neither (no limit)<sup>10</sup>.

SRT packet pacing can be summarized as follows. By default, the output rate of the live-mode SRT sender is tailored based on the input rate (the output of a streamer). The input rate (sendmsg API) is measured internally and the output pace is adjusted accordingly, including the configured overhead (default = 25%) that is added to permit the injection of retransmitted packets.

### Packet Probes

While SRT exercises a certain amount of control over packet flow, there are limits imposed by the inability to precisely calculate the capacity of the link. The technique that is used is to send “packet probes” every 16 packets with no inter-packet spacing<sup>11</sup>. At the receiver, the packet spacing is measured to see if network traversal introduces inter-packet delays. If there is a gap between the two packets when they arrive at the receiver, this is an indication of cross traffic, which would mean that the available network capacity is reduced. This helps to measure the capacity of the link. But the calculation of the spacing between packets is not controlled, so the available bandwidth remains difficult to determine.

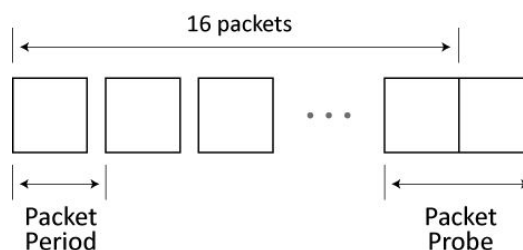

<sup>10</sup> If neither SRTO\_MAXBW nor SRTO\_INPUTBW is set, the default output ceiling is 30 mbps.

<sup>11</sup> Unfortunately this packet probe pair approach is better suited for calculating the available bandwidth of a link where the capacity is known (which is usually not the case). It is actually measuring the cross traffic inserted between UDT packets, where [capacity] – [cross traffic] = [available bandwidth].

## The Sender's Algorithm

Refer to Section 6.1 of the UDT IETF Internet Draft (draft-gg-udt-03.txt) for details.

## The Receiver's Algorithm

Refer to Section 6.2 of the UDT IETF Internet Draft (draft-gg-udt-03.txt) for details.

## Loss Information Compression Scheme

Refer to Section 6.4 of the UDT IETF Internet Draft (draft-gg-udt-03.txt) for details.

## UDP Multiplexer

SRT uses UDT's UDP multiplexer as is.

Refer to Section 3 of the UDT IETF Internet Draft (draft-gg-udt-03.txt) for details.

## Timers

SRT uses UDT's timers, but with some changes. The NAK timer has a minimum value that existed in the UDT4 code but is not described there. For SRT, this minimum value depends on the congestion control type being used.

Refer to Section 4 of the UDT IETF Internet Draft (draft-gg-udt-03.txt) for details.

## Flow Control

Flow control, in terms of transfers, allows a stream to be a good Internet citizen. Flow control in SRT's live mode is really the absence of flow control. SRT does not take the TCP "slow down quickly, speed up slowly" approach where, when you detect congestion, you slow down. This does not work with real-time streaming. SRT tries to maintain the rate, even during periods of congestion. This makes it worse because more retransmissions are required, which can't be reduced by the SRT protocol alone. It would have to be done outside of SRT with network adaptive encoding, where the control would be at the input.

Refer to Section 6.3 of the UDT IETF Internet Draft (draft-gg-udt-03.txt) for more details.

## Configurable Congestion Control (CCC)

The UDT protocol features a congestion control mechanism that allows it to be a good network citizen by holding back packets as network congestion increases. This was an acceptable approach for file transfers that are not time constrained. But in order to accommodate the needs of live streaming, this UDT mechanism was modified in early versions of SRT to minimize or eliminate packet delays. Later versions of SRT have restored congestion control functionality to support the transmission of either live streams or large files.

The UDT congestion control factory checks the round-trip time, looks at its statistics, and then slows down the output of packets as needed by adjusting the packet period. In periods of congestion, it might completely stop sending. If the number of lost packets becomes significant, it can block the main stream and focus on the lost packets. This is not suitable for real-time transmission, where it is better to drop packets or frames than to try to get the queue back to a reliable state.

The UDT congestion control factory can be customized to a limited degree by an application. This code has been significantly modified in SRT to add additional parameters, including a new congestion control class to enable file transfer among other things.

Refer to Section 7 of the UDT IETF Internet Draft ([draft-gg-udt-03.txt](#)) for details.

### CCC Interface

Refer to Section 7.1 of the UDT IETF Internet Draft ([draft-gg-udt-03.txt](#)) for details.

### Native Control Algorithm

Refer to Section 7.2 of the UDT IETF Internet Draft ([draft-gg-udt-03.txt](#)) for details.

## SRT Encryption

This section describes the encryption mechanism that protects the payload of SRT streams. Despite using standard cryptographic algorithms, the mechanism is unique and does not interoperate with any known third party stream encryption method.

### Overview

AES in counter mode (AES-CTR) is used with a short-lived key to encrypt the media stream. This cipher is suitable for random access of a continuous stream, content protection (used by HDCP 2.0), and strong confidentiality when the counter is managed properly. SRT implements encryption using AES-CTR mode, effectively using encryption to decrypt an encrypted packet.



SRT encrypts the media stream at the Transmission Payload level (UDP payload of MPEG-TS/UDP encapsulation, which is about 7 MPEG-TS packets of 188 bytes each). A small packet header is required to keep the synchronization of the cipher counter between the encoder and the decoders. No padding is required by counter mode ciphers.

What is encrypted is a 128-bit counter, which is then used to do an XOR with each block of 128 bits in a packet, resulting in the ciphertext to transmit (this is the XOR technique for counter mode).

The counter for AES-CTR is the size of the cipher's block, i.e. 128 bits. It is derived from a 128-bit sequence consisting of (1) a block counter in the least significant 16 bits, which counts the blocks in a packet, (2) a packet index —based on the packet sequence number in the UDT header— in the next 32 bits, and (3) eighty bits that are zeroes. The upper 112 bits of this sequence are XORed with an initialization vector (IV) to produce a unique counter for each crypto block. Note that the block counter is unique for the duration of the session. The same counter cannot be used twice.

This key used for encryption is called the “Stream Encrypting Key” (SEK), which is used for  $2^{25}$  packets. The short-lived SEK is generated by the sender using a pseudo-random number generator (PRNG), and transmitted within the stream (KM Tx Period), wrapped with another longer-term key, the Key Encrypting Key (KEK), using a known AES key wrap protocol.

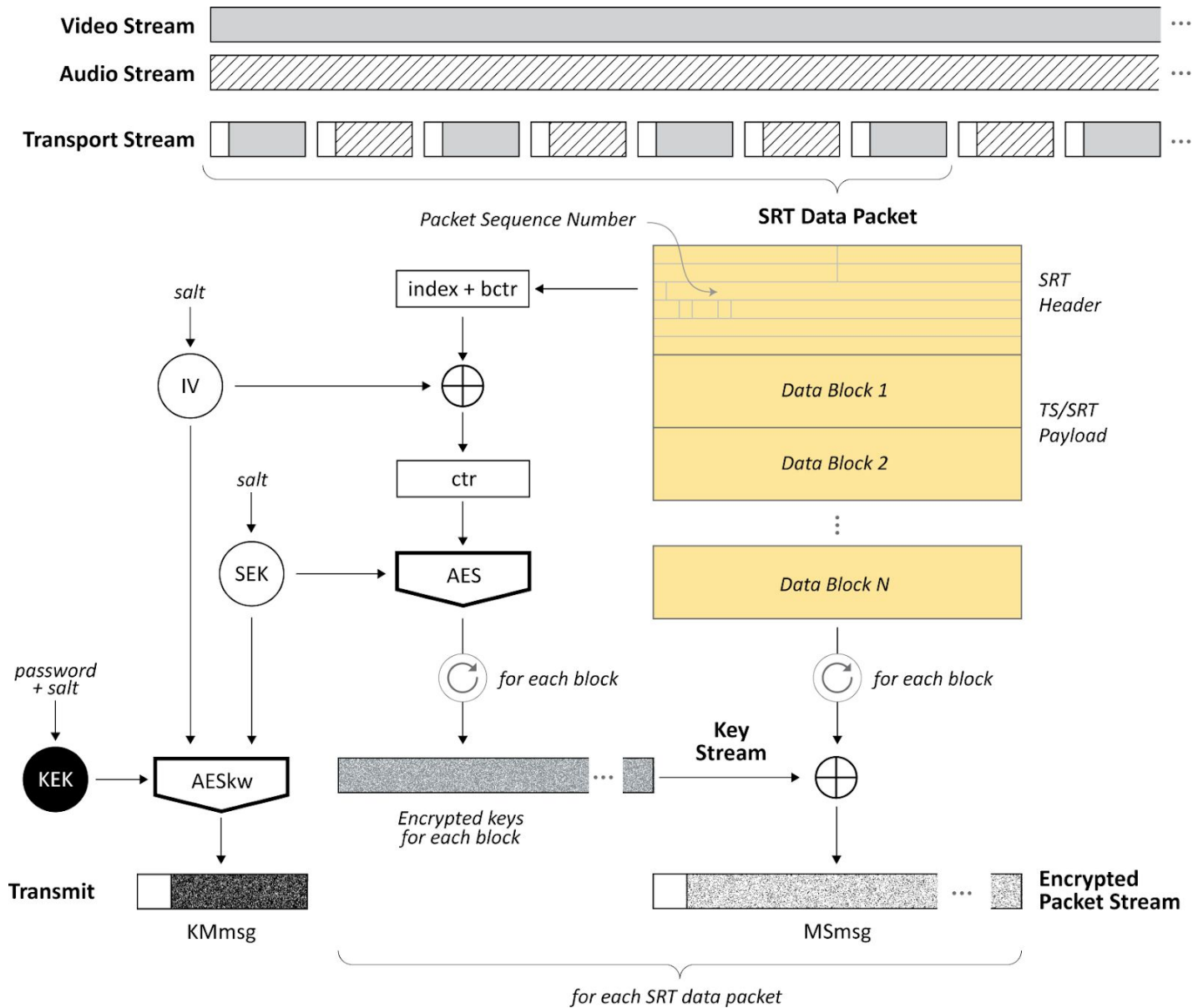

For connection-oriented transport such as SRT, there is no need to periodically transmit the short-lived key since no party can join the stream at any time. The keying material is transmitted within the connection handshake packets, and for a short period when rekeying occurs.

The KEK is derived from a secret shared between the sender and the receiver. The shared secret provides access to the stream key, which provides access to the protected media stream. The distribution and management of the secret is more flexible than the stream encrypting key.

The KEK has to be at least as long as the SEK. So, for example, to protect with AES-256, the KEK should use AES-256 as well. Protecting a 256-bit key with one that is 128 bits would weaken the security. For this reason, the SEK configuration is used to generate the KEK.

The KEK is generated by a password-based key generation function (PBKDF2), which uses the passphrase, a number of iterations (2048), a keyed-hash (HMAC-SHA1), and a length KEYLEN. The PBKDF2 function hashes the passphrase to make a long string, by repetition or padding. The

number of iterations is based on how much time can be given to the process without it becoming disruptive.

The KEK is used to generate a wrap that is put in a key material (KM) message to send to the receiver. The KM message contains the key length, the salt (one of the arguments provided to the PBKDF2 function), the protocol being used (AES-256 in this case) and the AES counter (which will eventually change).

On the other side, the receiver attempts to decode the wrap to obtain the key. In the protocol for the wrap there is a padding, which is a known template, so the receiver knows from the KM that it has the right KEK to decode the SEK. The SEK (generated and transmitted by the sender) is random, and cannot be known in advance. The KEK formula is calculated on both sides, with the difference that the receiver gets the key length (KEYLEN) from the sender via the key material (KM). It is the sender who decides on the configured length. The receiver obtains it from the material sent by the sender. This is why the length is not configured on a decoder, thus avoiding the need to match.

The receiver returns the same KM message to show that it has the same information as the sender, and that the encoded material will be decrypted. If the receiver does not return this status, this means that any encrypted packets from the sender will be lost. Even if they are transmitted successfully, the receiver will be unable to decrypt them, and so will be dropped. In the UDT design, even if one peer could not decrypt, this did not mean that others shouldn't receive the information. In UDT, the key exchange is a one way process, where the key is regularly injected into a stream so that it can be received at any time. But with SRT the connection is established in the beginning, so the key exchange happens then. It can't be done just anywhere in the stream.

The sequence number starts randomly in an SRT handshake. So when packet encryption starts, the encryption library counts the packets themselves. This is where the key regeneration is programmed.

The short lived SEK is regenerated for cryptographic reasons when enough packets have been encrypted with it (KM Refresh Rate). Currently the default is  $2^{25}$ , with a pre-announcement period of 4000 packets (i.e. a new key is generated, wrapped, and sent at  $2^{25}$  minus 4000 packets). Even and odd keys<sup>12</sup> are alternated this way. The packets with the earlier key (we'll call it key #1, or "odd") will continue to be sent. The receiver will receive the new key #2 (even), then decrypt and unwrap it. The receiver will reply to the sender if it is able to understand. Once the sender gets to the  $2^{25}$  packet using the odd key (key #1), it will then start to send packets with the even key (key #2). It knows that the receiver has what it needs to decrypt (SEK #2). This happens transparently, from one packet to the next. At  $2^{25}$  plus 4000 packets the first key will be decommissioned automatically.

---

<sup>12</sup> Digital Video Broadcasting (DVB) encryption  
([https://www.dvb.org/resources/public/standards/a125\\_dvb-csa3.pdf](https://www.dvb.org/resources/public/standards/a125_dvb-csa3.pdf))

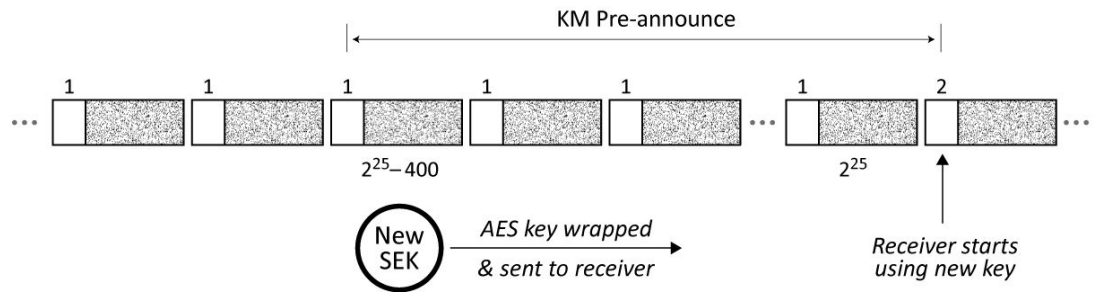

The keys live in parallel for certain period of time. A bit before and a bit after the  $2^{25}$  mark there are two keys that exist in parallel, in case there is retransmission. It is possible for packets with the older key to arrive at the receiver a bit late. Each packet contains a description of which key it requires, so the receiver will still the ability to decrypt it.

KM Refresh Rate and KM Pre-Announce are system parameters that can be configurable options if shorter time than the cryptographic limit is required (for example, to limit the material obtained from a compromised SEK).

In terms of the encryption capabilities of sender and receiver for the different versions of SRT, in the beginning it wasn't complicated. In HSv4, the UDT handshake occurs first, over a period of  $2 \times \text{RTT}$ . Then comes the SRT extension exchange, following which the sender would send the key material to the receiver, which was acknowledged with a response packet. All of this takes an additional  $2 \times \text{RTT}$ .

More recent versions of SRT consolidate everything in the handshake itself. In the new HSv5, the keying material piggybacks on the second round-trip, including the response. The handshake initiator sends the key length, and then the key material exchange happens on the last trip.

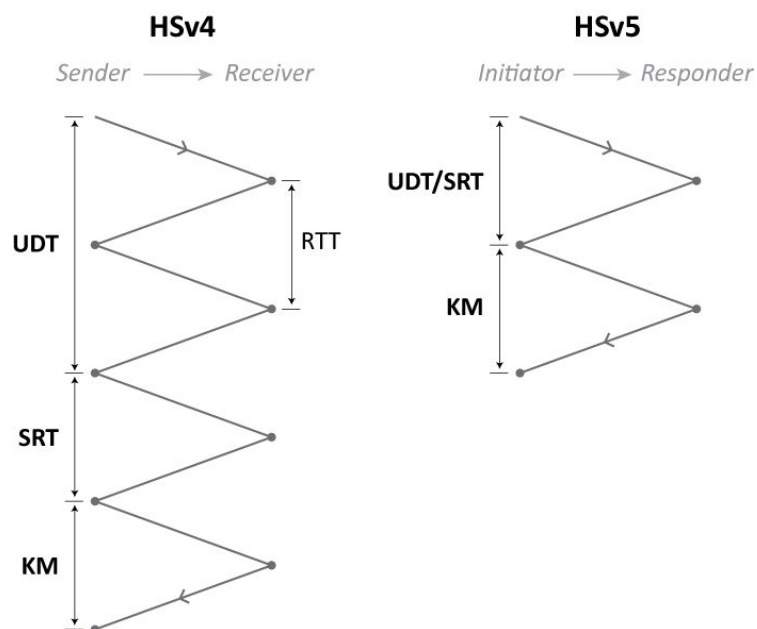

In Haivision products, for example, the key length is configured on the sender, then sent to the receiver, which will generate its keying material based on that value, and send a response back

to the sender. But this can be configured in another way. There is no obligation to have the same set of keys for transmission and reception.

## Definitions

This section defines the elements of the SRT encryption mechanism.

### Ciphers (AES-CTR)

The payload is encrypted with a cipher in counter mode (AES-CTR). The AES counter mode is one of the only cipher modes suitable for continuous stream encryption that permits decryption from any point, without access to start of the stream (random access), and for the same reason tolerates packet lost. The Electronic Code Book (ECB) mode also has these characteristics but does not provide serious confidentiality and is not recommended in cryptography.

Integrity protection might eventually be achieved with an Authenticated Encryption with Associated Data (AEAD) cipher such as AES-CCM or AES-GCM. These cipher modes remove the need of a separate message authentication protocol such as SHA-2.

### Media Stream Message (MSmsg)

The Media Stream message is formed from the SRT media stream (data) packets with some elements of the SRT header used for the cryptography. An SRT header already carries a 32-bit packet sequence number that is used for the cipher's counter (ctr), with 2 bits taken from the header's message number (which is thereby reduced to 27 bits) for the encryption key (odd/even) indicator. Note that the message number field is used when messages larger than the MTU are sent, which is not the case for TS/SRT so the reduction to 27 bits is without consequence.

### Keying Material

For each stream, the sender generates a Stream Encrypting Key (SEK) and a Salt (not shown in Figure 1). For the initial implementation and for most envisioned scenarios where no separate authentication algorithm is used for message integrity, the SEK is used directly to encrypt the media stream. The Initial Vector (IV) for the counter is derived from the Salt only. In other scenarios, the SEK can be used along with the Salt as a key generating material to produce distinct encryption, authentication, and salt keys.

### Stream Encrypting Key (SEK)

The Stream Encrypting Key (SEK) is pseudo-random and different for each stream. It must be 128, 192, or 256 bits long for the AES-CTR ciphers. It is non-persistent and relatively short lived. In a typical scenario the SEK is expected to last, in cryptographic terms, around 37 days for a 31-bit counter ( $2^{31}$  packets / 667 packets/second).

The SEK is regenerated every time a stream starts and does not survive system reboot. It must be discarded before  $2^{31}$  packets are encrypted (31-bit packet index) and replaced seamlessly using an odd/even key mechanism described below. SRT is conservative and regenerates the SEK key every  $2^{25}$  packets (~6 hours in the above scenario of a 667 packets/second stream). Reusing an IV (often called "nonce") with the same key on different clear text is a known



catastrophic issue of counter mode ciphers. By regenerating the SEK each time a stream starts we remove the need for elaborate management of the IV to ensure uniqueness.

### Initialization Vector (IV)

The IV (also called “nonce” in the AES-CTR context) is a 112-bit random number. For the initial implementation of SRT and for most envisioned scenarios where no separate authentication algorithm is used for message integrity (Auth=0), the IV is derived from the salt only.

IV = MSB(112, Salt) ; Most significant 112 bits of the salt.

### Counter (ctr)

The counter for AES-CTR is the size of the cipher’s block, i.e. 128 bits. It is based on a block counter in the least significant 16 bits, for counting blocks of a packet, a packet index in the next 32 bits, and 80 zeroed bits. The upper 112 bits are XORed with the IV to produce a unique counter for each crypto block.

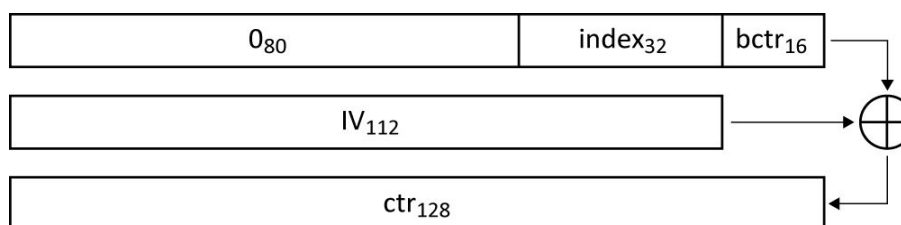

The block counter (bctr) is incremented for each cipher block while producing the key stream. The packet index is incremented for each packet submitted to the cipher. The IV is derived from the Salt provided with the Keying Material.

### Keying Material message (KMmsg)

The SEK and a salt are transported in-stream, in a Keying Material message (KMmsg), implemented as a custom SRT control packet, wrapped with a longer term Key Encrypting Key (KEK) using AES key wrap<sup>13</sup> [RFC3394].

Transmitting a key in-band is not original to the SRT protocol. It is used in DVB MPEG-TS where the stream encrypting key is transmitted in an Entitlement Control Message (ECM). It is also proposed in an IETF draft for SRTP for Encrypted Key Transport [SRTP-EKT].

The connection-oriented SRT KM control packet is transmitted at the start of the connection, before any data packet. In most cases, if the control packet is not lost, the receiver is able to decrypt starting with the first packet. Otherwise, the initial packets are dropped (or stored for later decryption) until the KM control packet is received (the SRT control packet is retransmitted until acknowledged by the receiver).

### Odd/Even Stream Encrypting Key (oSEK/eSEK)

To ensure seamless rekeying for cryptographic (counter exhausted) or access control reasons, SRT employs a two-key mechanism, similar to the one used with DVB systems. The two keys are identified as the odd key and the even key (oSEK/eSEK). An odd/even flag in the SRT data

<sup>13</sup> In future versions of SRT, it might be possible to implement a key wrapper with integrity such as AESKW [ANSX9.102] or AES-SIV [RFC5297].

header tells which key is in use. The next key to be used is transmitted in advance (KM Pre-Announce) to the receivers in an SRT control packet. When rekeying occurs, the SRT data header odd/even flag flips, and the receiver already has the new key in hand to continue decrypting the stream without missing a packet.

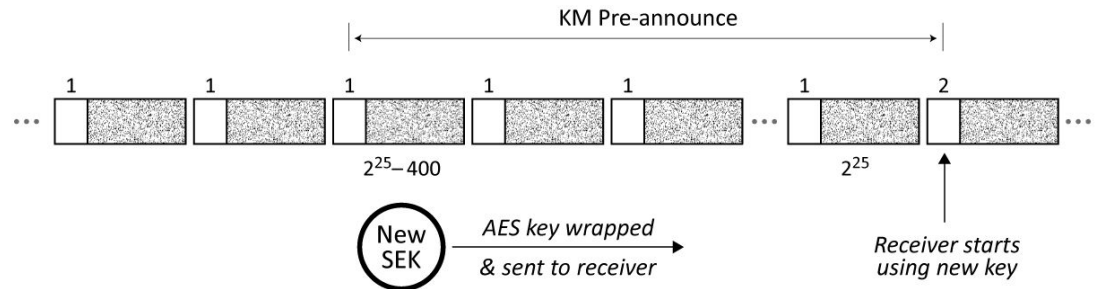

### Key Encrypting Key (KEK)

The Key Encrypting Key (KEK) is used by the sender to wrap the SEK, and by the receiver to unwrap it and then decrypt the stream. The KEK must be at least the size of the key it protects, the SEK. The KEK is derived from a shared secret, a pre-shared password by default.

The KEK is derived with the PBKDF2 [PKCS5] derivation function with the stream Salt and the shared secret for input. Each stream then uses a unique KEK to encrypt its Keying Material. A compromised KEK does not compromise other streams protected with the same shared secret (but a compromised shared secret compromises all streams protected with KEK derived from it). Late derivation of the KEK using stream Salt also permits the generation of a KEK of the proper size, based on the size of the key it protects.

The shared secret can be pre-shared; password derived [PKCS5]; distributed using a proprietary mechanism, or by using a standard key distribution mechanism such as GDOI [RFC 3547] or MIKEY [RFC 3830].

The cryptographic usage limit of the KEK is 248 wraps (AESKW) which means virtual infinity at the expected SEK rekeying rate (90,000 years to rekey 100 keys every second).

## Encryption Process Walkthrough

### Stream configuration

In the simplest stream protection form, a stream is configured with a password (preferably a passphrase) to enable encryption. The sender decides to protect or not. On the receiver, a configured passphrase is used only if the incoming media stream is encrypted. A receiver knows that a received stream is encrypted and how (cipher/key length), based on the received stream itself — not because it has a password configured.

In the absence of security policies, operators and admins can perform this task. The only other parameter to set in the initial implementation of SRT, which uses only AES-CTR, is the key size (actually the code book): 128, 192, or 256. This can be configured as fast, medium, or strong encryption.

A system-wide stream protection passphrase (and other crypto parameters) can also be set by a Security Officer. On the sender, a stream can be protected by only enabling encryption (using a system-wide passphrase derived key). On the receiver, no specific setting is required if the decoder detects encryption from the received stream and has access to the system-wide passphrase to decrypt it.

The Security Officer could also set policies to force stream encryption for all streams created by operators and admins, limit the cipher and key size selection, etc.

### Keying Material Generation

*SEK, Salt, and KEK*

For each protected stream, the encoder generates a random SEK and Salt. In the case of a pre-shared password derived key, it derives the KEK from the pre-shared secret and the 64 least significant bits of the Salt.

$$\text{SEK} = \text{PRNG}(\text{Klen})$$
$$\text{Salt} = \text{PRNG}(128)$$
$$\text{KEK} = \text{PBKDF2}(\text{password}, \text{LSB}(64, \text{Salt}), \text{Iter}, \text{Klen})$$

...where PRNG is a pseudo-random number generator, Klen is the key length (128, 192, 256), PBKDF2 is the PKCS #5 Password Based Key Derivation Function 2.0, and Iter is the iteration count (2048). For proper protection, the KEK must be at least as long as the key it protects.

### KMmsg

The encoder assembles the Keying Material message once for the life of the SEK and transmits it periodically. It may be assembled twice if the 2nd key (odd and even) is later added and transmitted in the same message for seamless rekeying (SEK = eSEK || oSEK).

$$\text{Wrap} = \text{AESkw}(\text{KEK}, \text{SEK})$$
$$\text{KMmsg} = \text{Header} \ || \ \text{CryptoInfo} \ || \ \text{Wrap}$$

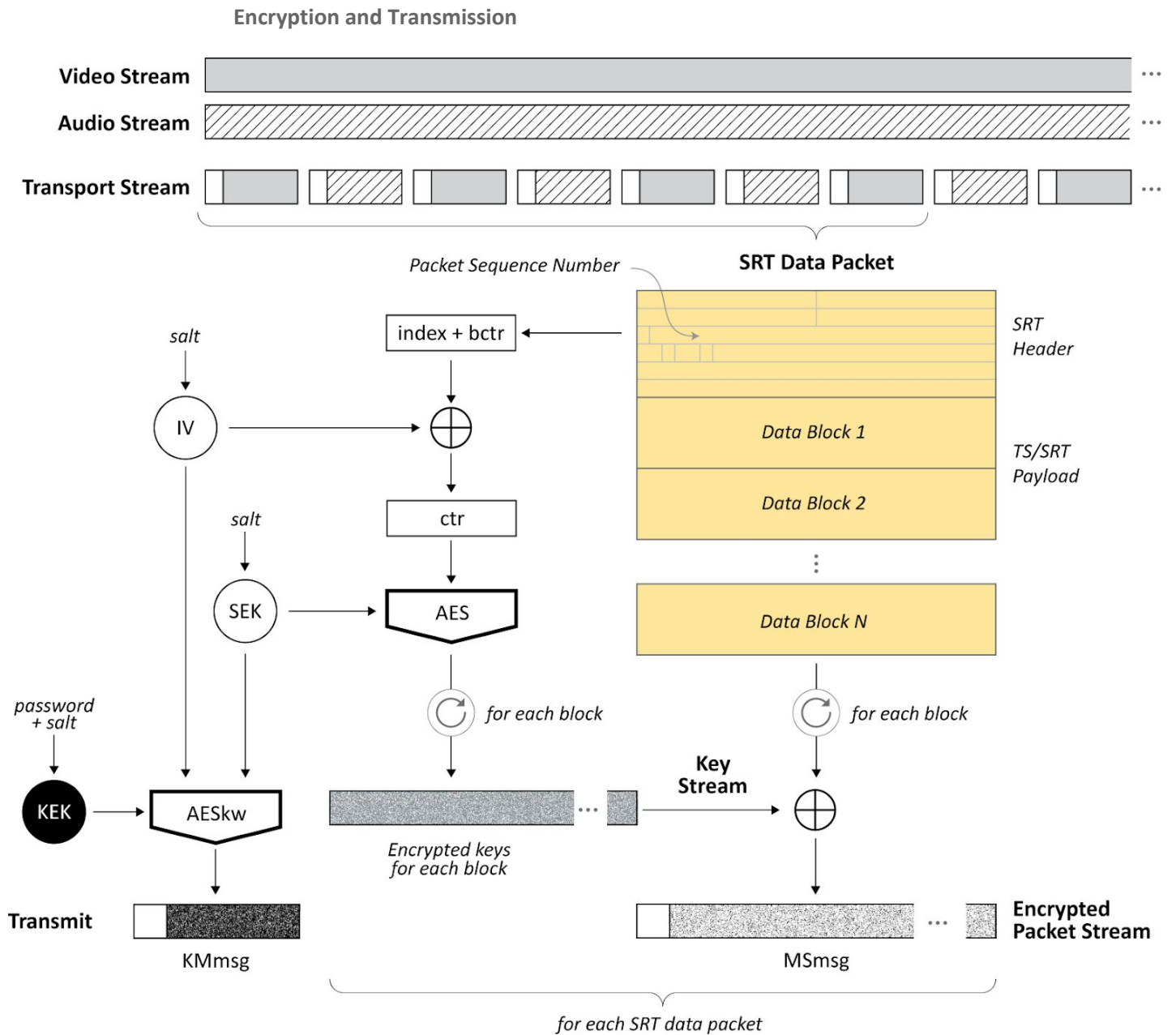

### KMmsg Transmission (KM Tx Period)

The sender transmits the KMmsg periodically (ex: every second).

### Key Stream Generation

When a co-processor is used for cryptography the key stream can be generated in parallel, in advance of the media stream. The initial counter is generated from the IV and the Salt.

$$IV = \text{MSB}(112, \text{Salt})$$

$$ctr = (IV_{112} || 016) \text{ XOR } (index_{32} || 016)$$

$$\text{KeyStream}[index] = \text{AES}(\text{SEK}, ctr) || \text{AES}(\text{SEK}, ctr+1) || \dots || \text{AES}(\text{SEK}, ctr+n-1)$$

index = index+1

...where n is the number of 128 bits block in the payload.

### Media Stream Message Generation

The TS/UDP payload is XORed with the Key stream:

$$MSmsg[index] = \text{Header} || \text{index} || (\text{KeyStream}[index] \text{ XOR } \text{payload}[index])$$

### Reception and Decryption

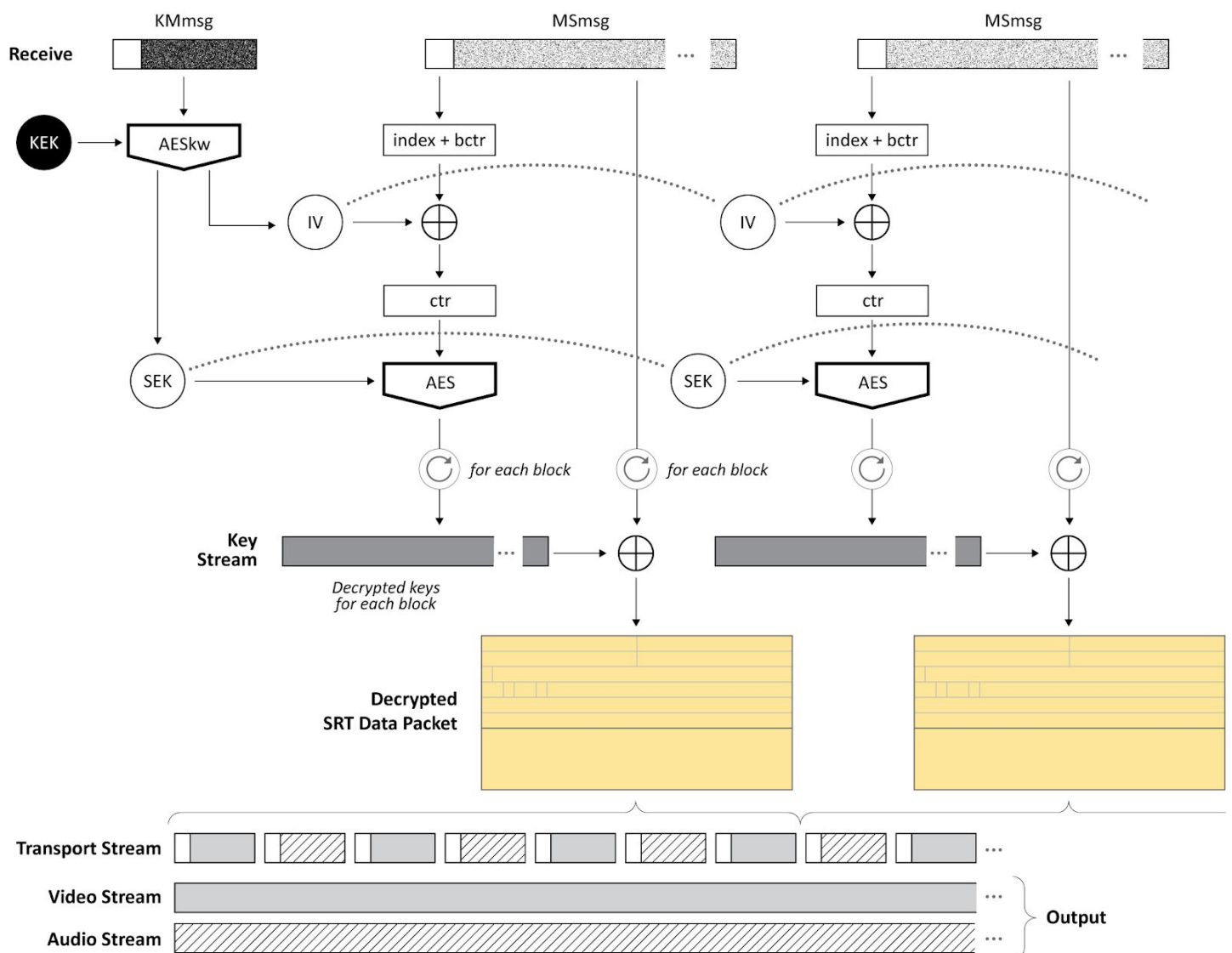

### Detect Encryption

The receiver of a stream can detect from the message whether or not the stream is encrypted.

### Regenerate the KEK, SEK and IV

If the receiver does not have the Keying Material, it waits for a KMmsg to extract the Salt and Wrap. With the pre-shared password and the Salt it regenerates the KEK and then unwrap the SEK. It checks the Wrap integrity from the Integrity Check Vector.

$$\text{KEK} = \text{PBKDF2}(\text{password}, \text{Salt}, \text{Iter}, \text{Klen})$$
$$\text{ICV} \ || \ \text{SEK} = \text{AESkw}(\text{KEK}, \text{Wrap})$$

### Generate Key Stream

With the next stream message (MSmsg) the receiver grabs the packet counter and odd/even key flag from the clear text header and primes the cipher to generate a key stream for some packets in advance.

### Counter Preset

As an optimization, while waiting for the first KMmsg, the decoder can grab the packet counter and odd/even flag from the stream message (MSmsg) received before the KMmsg and know what the packet counter of the next MSmsg should be, then prime the cipher earlier.

### Early Frames vs. Latency

Where the key stream is generated in any arrangement where a crypto processor can process the key stream in parallel, there is a choice between displaying the earlier frames received or achieving low latency.

When a decoder has primed the cipher to generate the key stream, it has the choice to (1) store the received stream packets until the key stream is ready, and then display the earliest received frame with some latency (the lag between the first packet buffered and the first packet decrypted and displayed), or (2) drop the early packets until the key stream is ready, and then achieve lower latency. It is assumed here that the crypto engine can thereafter generate the key stream as fast as it receives MSmsg.

The same reasoning applies when encrypted packets are received before the keying material at the start of a session. With TS/SRT, KMmsg is sent right after connection before any media stream packet, but it can be lost, and a retransmitted KMmsg can reach the receiver after the initial encrypted packets. SRT adds artificial latency to permit retransmission of lost packets, so it can enqueue encrypted packet and decrypt them upon delivery to the receiving application instead of upon reception.

While it would be possible to buffer the received stream packets before receiving the KMmsg, there is no guarantee that the odd or even key used to encrypt these messages is the one encrypted in the KMmsg received after, especially if backward secrecy is achieved (where a new receiver cannot decrypt an earlier stream).

## Messages

## Data Message Header

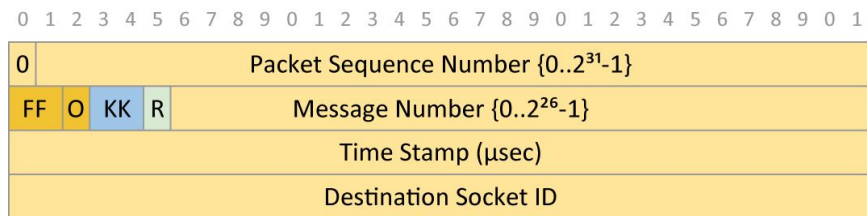

Field	Bits	Value	Description
0	1	0	SRT Data   Control packet identifier 0:data 1:control
FF	3		Packet Position in message 10:first 00:middle 01:last 11:only packet
KK			Odd/even encryption Key indicator 10:odd 01:even
R	1		(≥ libsrt 1.3)

## SRT Control Message Header

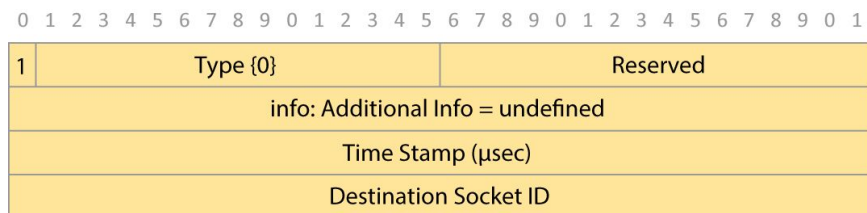

Field	Bits	Value	Description
1	1	1	SRT control packet identifier
Type	15	0x7FFF	SRT control packet type: custom

### SRT Keying Material Control Message (KMmsg)

The Keying Material message provides the information to decrypt the Media Stream message payload.



Field	Bits	Value	Description
0	1	0	Remnant from past header
Ver	3		SRT version
		1	Initial version
PT	4		Packet Type
		0	Reserved
		1	MSmsg
		2	KMmsg (always)
		7	Reserved to discriminate MPEG-TS packet (0x47=sync byte)
Signature	16	0x2029	Signature ('HAI' PnP Vendor ID in big endian order)
Resv	4	0	Reserved for flag extension or other usage
KEKI	32		KEK index (big endian order)
		0	Default stream associated key (stream/system default)
		1..255	Reserved for manually indexed keys
Cipher	8		Encryption cipher and mode
		0	None or KEKI indexed crypto context
		1	AES-ECB (potentially for VF 2.0 compatible message)
		2	AES-CTR [FP800-38A]



		x	AES-CCM [RFC3610] if message integrity required (FIPS 140-2 approved)
		x	AES-GCM if message integrity required (FIPS 140-3 & NSA Suite B)
Auth	8		Message Authentication Code algorithm
		0	None or KEKI indexed crypto context
SE	8		Stream Encapsulation
		0	Unspecified or KEKI indexed crypto context
		1	MPEG-TS/UDP
		2	MPEG-TS/SRT
Slen/4	4	0..255	Salt length in bytes divided by 4. Can be zero if no salt/IV present
Klen/4	4	0..255	SEK length in bytes divided by 4. Size of one key even if two keys present.
Salt	Slen*8		Salt key
Wrap	64+ n*Klen*8		Wrapped key(s) n = 1 or 2

## KEKI

The KEK index (KEKI) tells which KEK was used to wrap (and optionally authenticate) the SEK(s). With a key management system, the KEKI is used as one of the parameters (possibly with the IP address and port of the stream) to retrieve a cryptographic context. In the absence of a key management system, the value 0 is used to indicate the default key of the current stream.

If it is required to seamlessly change the KEK for good security practice (key lifetime elapsed), to preserve backward/forward secrecy when a new receiver joins/leaves, for a security breach (compromised KEK or device), or if there are multiple sensitive streams to protect (ex: secret, sensitive, public, etc.), then the system needs to manage multiple keys and this field tells which one to use.

## Auth

In the eventuality that a separate authentication protocol such as SHA2 is used for message integrity, the SAK (Stream Authentication Key) may be derived from the SEK instead of being carried in the KMmsg. The SEK then becomes a Key Generating Key and the Salt a master salt from which the stream encryption, authentication, and salt keys are derived. This is the method used for SRTP [RFC3711].

**Salt**

This field complements the keying material. It can carry a nonce; salting key; Initialization Vector, or be used as a generator for them.

**Wrap**

Once KMmsg is unwrapped, the following fields are revealed.

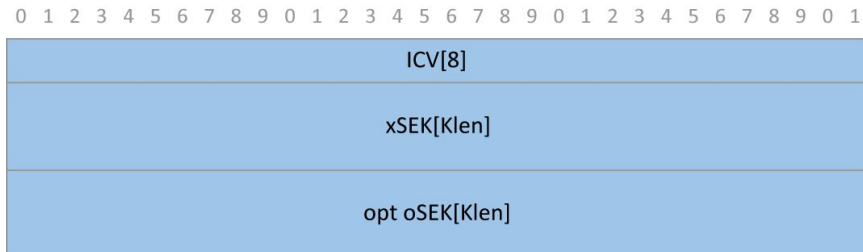

Field	Bits	Value	Description
ICV	64		64-bit Integrity Check Vector (AES key wrap integrity)
xSEK	Klen*8		Odd or Even key if one key (according to Flags) Even key if both keys
oSEK	Klen*8		Odd key if both keys

The same KMmsg can carry two keys only if they share the same KEKI and same length. If there is a security parameter change with SEK rekeying (key length or new KEKI), then a different KMmsg must be used to carry the odd and even key.

Note that the same Salt is reused on SEK rekeying. This does not break the nonce requirement of the counter mode that is used only once for a given key, and preserves the password-based derived KEK of this stream.

**ICV**

This field is used to detect if the keys were unwrapped properly. If the KEK in hand is invalid, validation fails and unwrapped keys are discarded.

**xSEK**

This field identifies an odd or even SEK. If only one key is present, the bit set in the Flags field tells which one it is. If both keys are present, then this field is eSEK (even key) and the next one is the odd key.

**oSEK**

This field is present only when the message carries the two SEKs. This may be only for a short period before re-keying the stream for a new receiver to decrypt the current stream, and for all members to prepare for seamless re-keying.

## Parameters

Parameter	Cfg	Default		Description
		TS/UDP	TS/SRT	
Passphrase	usr	none	none	SIZE[8..80]
Encryption (key length)	usr	128	128	none(0), fast (128), medium(192), strong(256)
Integrity	usr	0	0	none(0), others... (future)
Encryption cipher	sp	CTR	CTR	AES-xxx-CTR
AEAD cipher	sp			AES-xxx-CCM (future) AES-xxx-GCM (future)
Passphrase min length	sp	8	10	[8..80]
KM Tx Period (msec)	os	1000		100..60000 milliseconds
KM Refresh Rate (packets)	os	2 <sup>24</sup>	2 <sup>24</sup>	2 <sup>10</sup> ..2 <sup>32</sup> packets A power of 2 makes implementation easier
KM Pre-Announce (packets)	os	2 <sup>12</sup> 0x1000	0x10000	KM Switch Pre/Post Announce <= (KM Refresh Rate / 2)
PBKDF2 Iterations	sp	2048	2048	>=1000
PBKDF2 Hash Function	sp	X	X	SHA-1 SHA-2 (future: PKCS #5 v2.1)
PBKDF2 Salt size (bits)	sp	64	64	64 bits

usr: user configurable, sp: security policy (default: os), os: haios.ini [HAICRYPT]

## Security Issues

### Backward/Forward Secrecy

Backward secrecy is the confidentiality of past material with respect to a new member who has obtained the shared secret. If backward secrecy is required, the shared secret (pre-shared password) must be changed whenever a new member joins the community, since with in-stream key distribution, a recorded past encrypted stream can be decrypted with the shared secret used at that time. With out-of-band key distribution using access control, a past key could not be obtained without the shared secret, which is no longer available. Forward secrecy permits denial of access to the key, such as to a member you previously trusted. This is different from Perfect Forward Secrecy (PFS) in which a compromised long-term key (KEK) does not compromise past sessions keys (SEK). PFS is normally achieved with a key exchange mechanism such as Ephemeral Diffie Hellman.

### Header Encryption

While encrypting the whole packet, including protocol headers, may look more secure, this raises security concerns. Headers have known content (example: MPEG-TS sync byte 0x47) that facilitates brute force and dictionary attacks, allowing them to know they succeeded in cracking a key (0x47 every 188th byte of the MPEG-TS packet). The remedy against a brute force attack is a longer key (longer crack time) and shorter key lifetime (change key before time required to crack with current technology). The SEK will not last longer than  $2^{24}$  packets by default, but this may be too long at low bit rates. A configurable SEK lifetime in units of time instead of packets would help (the first limit reached triggers rekeying).

### Pause, Still Image, Blackout, and Mute

Pause, still image, blackout, and mute on an encoder shall disable encryption. Known input encrypted with a different key stream (counter increasing) is material for hackers.

To preserve confidentiality, a pause shall not display a still frame of the input signal unencrypted but shall blackout when disabling encryption.

### Stream Protection Policy

In some installations, the audio/video input of an encoder might be too sensitive for a Security Officer to risk the possibility of operators or admins sending out unprotected streams. On such systems, the SO would configure a system-wide encryption pre-shared password (independent of the streams), and set a policy to force stream encryption.

### Storage

Password-derived keys are unique for each stream, so what is pre-shared is the password. It must not be stored in the default configuration file readable by all, nor be dumped or listed in any trace. A system security module can be used to store or encrypt the password. A shadow system with a reference in the configuration file to the password stored in a shadow file only readable by root may be sufficient.

### Configuration Sanity

It is preferable not to configure passwords or keys using telnet or HTTP, even if the password is obfuscated on the screen, if it is carried in the clear between the configuration system and the

sender/receiver. A system's CLI and Web interface shall be able to detect SSH/HTTPS (vs. telnet/HTTP) to permit security information settings only when they can securely do so.

### KEK Size

The KEK size cannot be smaller than the SEK to wrap. With a password derived KEK, the problem is solved by generating a KEK of the required size for each stream.

For a KEK from other sources to wrap an SEK of mixed sizes (128, 192, 256 bits), a 256-bit KEK could be used all the time. Performance should be evaluated to see if using a 256-bit KEK to decrypt a 128-bit SEK incurs unnecessary delays in stream decoding. An IP core can be used if a hardware implementation is desirable. Protecting a 128-bit key with a 256-bit KEK provides no more security than with a 128-bit KEK. Another solution could be to use PBKDF2 even for non-password based KEK material.

### Implementation Notes

#### PBKDF2

OpenSSL supports the PKCS #5 Password-Based Key Derivation Function version 2. The function `PKCS5_PBKDF2_HMAC_SHA1` performs this task.

Starting with version 1.0.0, OpenSSL implements the PKCS #5 version 2.1 added SHA-2 message digest functions for PBKDF2 (SHA224, SHA256, SHA384, SHA512). The generic function `PKCS5_PBKDF2_HMAC` needs the message digest algorithm in its parameters.

#### AES Key Wrap

OpenSSL supports the AES key wrap as defined in RFC3394 with the functions `AES_wrap_key()` and `AES_unwrap_key()`. To support material size that is not a multiple of 64 bits, standard padding for AESkw [RFC5649] is used.

#### KMmsg Caching

The KMmsg shall be cached on both the sender and receiver to prevent encrypting/decrypting the same message over and over again. PKCS #5 is CPU intensive. Senders retransmit cached KMmsg periodically (KM Tx Period) as long as it is valid(TS/UDP) or until it is acknowledged(TS/SRT). Receivers compare the received KMmsg to the cached KMmsg and discard it without decrypting it if nothing has changed.

At the expense of some transmission and CPU bandwidth, message integrity can be added to whole KMmsg using the ANS X9.102 AESKW mechanism. The OpenSSL AES key wrap functions can be used but with a different input, also providing a longer output.

#### Limitations

- (1) Encryption applies only to data packets, and not the header, which is needed for decrypting because it contains the sequence number (counter) needed to regenerate the decryption key.
- (2) It is currently not possible to route an encrypted SRT stream via an intermediate device, such as a gateway. The keys are exchanged during the handshake, and the handshake is point-to-point. Introducing an intermediate device would require another session, and therefore another counter.

End-to-end encryption would require the ability to pull the counter out and insert it in another packet — to force the counter, instead of depending on a random number, so that the sequence at the other end would be able to be decrypted.

Making encryption work without having the intermediate devices decrypt would be practical for a cloud service. But the problem is in the sequence number because it is determined at the moment of the SRT handshake by exchanging a random number. To do this end-to-end would require propagating the handshake from one end to the other by pulling it out of the ancillary data, and then re-injecting it in the appropriate place.

As a packet with a sequence number and encrypted payload passes through an intermediate device, there is another session, and therefore another sequence. The packet's ciphertext payload would have to be put into a new packet with a new sequence number.

## SRT Handshake

### Overview

SRT is a connection protocol, and as such it embraces the concepts of *connection* and *session*. The UDP system protocol is used by SRT for sending data as well as special control packets, also referred to as *commands*.

An SRT connection is characterized by the fact that it is:

- first engaged by a *handshake* process
- maintained as long as any packets are being exchanged in a timely manner
- considered closed when a party receives the appropriate close command from its peer (connection closed by the foreign host), or when it receives no packets at all for some predefined time (connection broken on timeout).

Just like its predecessor UDT, SRT supports two connection configurations:

1. Caller-Listener, where one side waits for the other to initiate a connection
2. Rendezvous, where both sides attempt to initiate a connection

As SRT development has evolved, two handshaking mechanisms have emerged:

1. the legacy UDT handshake, with the “SRT” part of the handshake implemented as extended control messages; this is the only mechanism in SRT versions 1.2 and lower, and is known as HSv4 (where the number 4 refers to the last UDT version)
2. the new integrated handshake, known as HSv5, where all the required information concerning the connection is interchanged completely in the handshake process

The version compatibility requirements are such that if one side of the connection only understands HSv4, the connection is made according to HSv4 rules. Otherwise, if both sides are at SRT version 1.3.0 or greater, HSv5 is used. As the new handshake supports several features that might be mandatory for a particular application, it is also possible to reject an HSv4-to-HSv5 connection by setting the `SRTO_MINVERSION` socket option. The value for this option is an integer with the version encoded in hex. For example:

```
int req_version = 0x00010300; // 1.3.0
srt_setsockopt(s, SRTO_MINVERSION, &req_version, sizeof(int));
```

**IMPORTANT:** An SRT application must do either of these two things:

- be HSv4 compatible; in this case it must:
  - NOT use any new features in 1.3.0 or higher (such as bidirectional transmission or Stream ID)
  - ALWAYS set `SRTO_SENDER` to true on the sender side
- require HSv5; if so, it must prevent connections to any older versions of SRT by setting the minimum version 1.3.0 as shown above.

### Handshake Structure

The control information field of the handshake control packet, which comes immediately after the UDT header and SRT header, consists of the following 32-bit fields in order:

Field	Description
<i>Version</i>	Contains number 4 in SRT before 1.3.0 (HSv4). It contains 4 or 5 (HSv5) depending on the handshake phase in SRT 1.3.0 and higher.
<i>Type</i>	In SRT before 1.3.0 (HSv4) must be the value of SOCK_DGRAM, which is 2. For usage in later versions of SRT see the “Type field” section below.
<i>ISN</i>	Initial Sequence Number; the sequence number for the first data packet
<i>MSS</i>	Maximum Segment Size, which is typically 1500, but can be less
<i>FlightFlagSize</i>	Maximum number of buffers allowed to be “in flight” (sent and not ACK-ed)
<i>ReqType</i>	Request type (see below)
<i>ID</i>	The SOURCE socket ID from which the message is issued (destination socket ID is in SRT header)
<i>Cookie</i>	Cookie used for various processing (see below)
<i>PeerIP</i>	Placeholder for the sender’s IPv4 or IPv6 IP address, consisting of four 32-bit fields

Here is a representation of the HSv4 handshake structure (which follows immediately after the SRT control packet header):

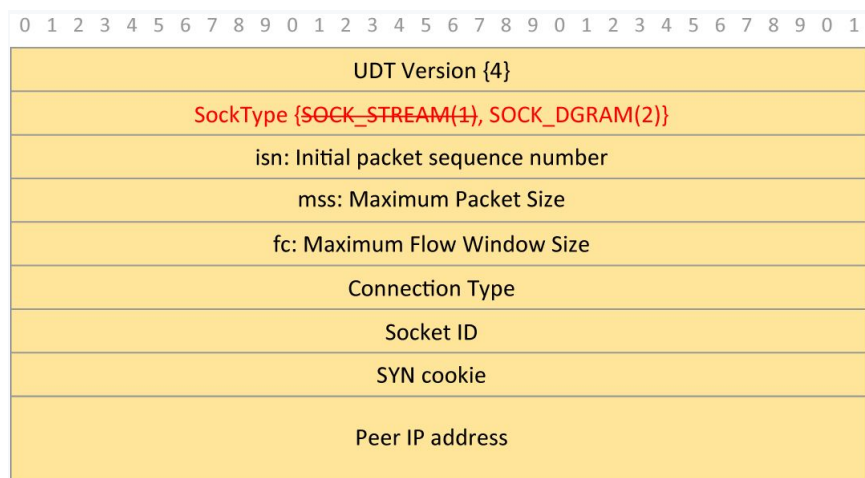

And here is the equivalent portion of the HSv5 handshake structure (to simplify the comparison here, the extended portion of the HSv5 handshake structure is not shown. See the “UDT Legacy” and “SRT Extended” Handshakes section for details):



0 1 2 3 4 5 6 7 8 9 0 1 2 3 4 5 6 7 8 9 0 1 2 3 4 5 6 7 8 9 0 1															
UDT Version {5}															
EncrFld {0,2,3,4}								ExtFld{0..7, 4a17h}							
isn: Initial packet sequence number															
mss: Maximum Packet Size															
fc: Maximum Flow Window Size															
Connection Type															
Socket ID															
SYN cookie															
Peer IP address															

The HSv4 (UDT-legacy based) handshake is based on two rules:

1. The complete handshake process, which establishes the connection, is the same as the UDT handshake.
2. The required SRT data interchange is done after the connection is established using SRT Extended Message with the following Extended Types:
  - SRT\_CMD\_HSREQ/SRT\_CMD\_HSRSP, which exchange special SRT flags as well as a latency value
  - SRT\_CMD\_KMREQ/SRT\_CMD\_KMRSP (optional), which exchange the wrapped stream encryption key used with encryption (KMRSP is used only for confirmation or error reporting)

**IMPORTANT:** *There are two rules in the UDT code that continue to apply to SRT version 1.2.0 and earlier, and therefore affect the prerequisites for any future versions of the protocol:*

1. *The initial handshake response message coming from the Listener side DOES NOT REWRITE the Version field (it's simply blindly copied from the handshake request message received).*
2. *The size of the handshake message must be exactly equal to the legacy UDT handshake structure, otherwise the message is silently rejected.*

As of SRT version 1.3.0 with HSv5 the handshake must only satisfy the minimum size. However, the code cannot rely on this until each peer is certain about the SRT version of the other.

Even in HSv5, the Caller must first set two fields in the initial handshake message:

- Version = 4
- Type = UDT\_DGRAM

The version recognition relies on the fact that the Listener returns a version of 5 (or potentially higher) if it is capable, but the Caller must set the Version to 4 to make sure that the Listener copies this value, which is how an HSv4 caller is recognized. This allows SRT to handle the following combinations:

1. HSv5 Caller vs. HSv4 Listener: The Listener returns version 4 to the Caller, so the Caller knows it should use HSv4, and then continues the handshake the old way.
2. HSv4 Caller vs. HSv5 Listener: The Caller sends version 4 and the Listener returns version 5. The Caller ignores this value, however, and sends the second phase of the handshake still using version 4. This is how the Listener recognizes the HSv4 client.
3. Both HSv5: The Listener responds with version 5 (or potentially higher in future) and the HSv5 Caller recognizes this value as HSv5 (or higher). The Caller then initiates the second phase of the handshake according to HSv5 rules.

With Rendezvous there's no problem because both sides try to connect to one another, so there's no copying of the handshake data. Each side crafts its own handshake individually. If the value of the Version field is 5 from the very beginning, and if there are any extension flags set in the Type field (see note below), the rules of HSv5 apply. But if one party is using version 4, the handshake continues as HSv4.

**NOTE:** *Previously, the SocketType field contained only the extension flags, but now it also contains the encryption flag. For HSv5 rules to apply the extension flag needs to be expressly set.*

The “Legacy” and “SRT Extended” Handshakes

### Legacy Handshake

The first versions of SRT did not change anything in the UDT handshake mechanisms, which are identified as HSv4. Here the connection process is the same as it was in UDT, and any extended SRT handshake operations are done after the HSv4 handshake is done and connection established.

The HSv5 handshake was first introduced in SRT version 1.3.0. It includes all the extended SRT handshake operations in the overall handshake process (known as “integrated handshake”), which means that these data are considered exchanged and agreed upon at the moment when the connection is established.

### Initiator and Responder

The addition of a new handshake mechanism necessitates the introduction of two new roles, “Initiator” and “Responder”:

- *Initiator:* Starts the extended SRT handshake process and sends appropriate SRT extended handshake requests
- *Responder:* Expects the SRT extended handshake requests to be sent by the Initiator and sends SRT extended handshake responses back

There are two basic types of SRT handshake extensions that are exchanged in both handshake versions (HSv5 introduces some more extensions):

- SRT\_CMD\_HSREQ: Exchanges the basic SRT information
- SRT\_CMD\_KMREQ: Exchanges the wrapped stream encryption key (used only if encryption is requested)

The Initiator and Responder roles are assigned differently in *HSv4* and *HSv5*.

For an *HSv4* handshake the assignments are simple:

- Initiator is the sender, which is the party that has set the `SRTO_SENDER` socket option to *true*.
- Responder is the receiver, which is the party that has set `SRTO_SENDER` to *false* (default).

Note that these roles are independent of the connection mode (Caller/Listener/Rendezvous), and that the behavior is undefined if `SRTO_SENDER` has the same value on both parties.

For an *HSv5* handshake, the roles are dependent of the connection mode:

- For Caller-Listener connections:
  - the Caller is the Initiator
  - the Listener is the Responder
- For Rendezvous connections:
  - The Initiator and Responder roles are assigned based on the initial data interchange during the handshake (see [The Rendezvous Handshake](#) below)

Note that if the handshake can be done as *HSv5*, the connection is always considered bidirectional and the `SRTO_SENDER` flag is unused.

### The Request Type Field

The `ReqType` field in the Handshake Structure (see above) indicates the handshake message type.

- Caller-Listener Request Types:
  - a. Caller to Listener: `INDUCTION(1)`
  - b. Listener to Caller: `INDUCTION(1)`: reports cookie
  - c. Caller to Listener: `CONCLUSION(-1)`: uses previously returned cookie
  - d. Listener to Caller: `CONCLUSION (-1)`: confirms connection established
- Rendezvous Request Types:
  - a. After starting the connection: `WAVEHAND(0)`
  - b. After receiving the above message from the peer: `CONCLUSION(-1)`
  - c. After receiving the above message from the peer: `AGREEMENT(-2)`.

Note that the Rendezvous process is different in *HSv4* and *HSv5*, as the latter is based on a state machine.

### The Type Field

There are two possible interpretations of the `Type` field. The first is the legacy UDT “socket type”, of which there are two: `STREAM(1)` and `DGRAM(2)`. In SRT only `UDT_DGRAM` is allowed. This legacy interpretation is applied in the following circumstances:

- in an `INDUCTION` message sent initially by the Caller
- in an `INDUCTION` message sent back by the *HSv4* Listener
- in an `CONCLUSION` message, if the other party was detected as *HSv4*

For more information on Induction and Conclusion see the Caller-Listener Handshake section below.

UDT interpreted the Type field as either a Stream or Datagram type, and rejected the connection if the parties each used a different type. Since SRT only uses the Datagram type, HSv5 uses only the DGRAM value for this field in cases where the message is going to be sent to an HSv4 party (which follows the UDT interpretation).

In all other cases Type follows the HSv5 interpretation and consists of the following:

- an upper 16-bit field (0 - 15) reserved for encryption flags
- a lower 16-bit field (16 - 31) reserved for extension flags

The extension flags field should have the following value:

- in a CONCLUSION message, it should contain a combination of extension flags (with the HS\_EXT\_ prefix)
- in a INDUCTION message sent back by the Listener it should contain SrtHSRequest::SRT\_MAGIC\_CODE (0x4A17)
- in all other cases it should be 0.

The encryption flags currently occupy only 3 out of 16 bits, which are used to advertise a value for PBKEYLEN (packet based key length). This value is taken from the SRTO\_PBKEYLEN option, divided by 8, giving possible values of:

- 2 (AES-128)
- 3 (AES-192)
- 4 (AES-256)
- 0 (PBKEYLEN not advertised)

The PBKEYLEN advertisement is required due to the fact that while the Sender should decide the PBKEYLEN, in HSv5 the Sender might be the Responder. Therefore PBKEYLEN is advertised to the Initiator so that it gets this value before it starts creating the SEK on its side, to be then sent to the Responder.

**REMINDER:** *Initiator and Responder roles are assigned differently in HSv4 and HSv5. See the Initiator and Responder section above.*

The specification of PBKEYLEN is decided by the Sender. When the transmission is bidirectional, this value must be agreed upon at the outset because when both are set, the Responder wins. For Caller-Listener connections it is reasonable to set this value on the Listener only. In the case of Rendezvous the only reasonable approach is to decide upon the correct value from the different sources and to set it on both parties (note that AES-128 is the default).

## The Caller-Listener Handshake

This section describes the handshaking process where a Listener is waiting for an incoming packet on a bound UDP port, which should be an SRT handshake command (UMSG\_HANDSHAKE) from a Caller. The process has two phases: *induction* and *conclusion*.

### The Induction Phase

The Caller begins by sending an “induction” message, which contains the following (significant) fields:

- Version: must always be 4
- Type: UDT\_DGRAM (2)
- ReqType: URQ\_INDUCTION
- ID: Socket ID of the Caller
- Cookie: 0

The Destination Socket ID (in the SRT header) in this message is 0, which is interpreted as a connection request.

**NOTE:** *This phase serves only to set a cookie on the Listener so that it doesn't allocate resources, thus mitigating a potential DOS attack that might be perpetrated by flooding the Listener with handshake commands.*

An HSv4 Listener responds with exactly the same values, except:

- ID: Socket ID of the HSv4 Listener
- SYN Cookie: a cookie that is crafted based on host, port and current time with 1 minute accuracy

An HSv5 Listener responds with the following:

- Version: 5
- Type: Extension Field (lower 16 bits): SrtHSRequest::SRT\_MAGIC\_CODE  
Encryption Field (upper 16 bits): Advertised PBKEYLEN
- ReqType: (UDT Connection Type) URQ\_INDUCTION
- ID: Socket ID of the HSv5 Listener
- SYN Cookie: a cookie that is crafted based on host, port and current time with 1 minute accuracy

**NOTE:** *The HSv5 Listener still doesn't know the version of the Caller, and it responds with the same set of values regardless of whether the Caller is version 4 or 5.*

The important differences between HSv4 and HSv5 in this respect are:

1. The HSv4 party completely ignores the values reported in Version and Type. It is, however, interested in the Cookie value, as this must be passed to the next phase. It does interpret these fields, but only in the “conclusion” message.

2. The HSv5 party does interpret the values in Version and Type. If it receives the value 5 in Version, it understands that it comes from an HSv5 party, so it knows that it should prepare the proper HSv5 messages in the next phase. It also checks the following in the Type field:
  - whether the lower 16-bit field (extension flags) contains the magic value (see the [Type Field](#) section above); otherwise the connection is rejected. This is a contingency for the case where someone who, in attempting to extend UDT independently, increases the Version value to 5 and tries to test it against SRT.
  - whether the upper 16-bit field (encryption flags) contain a non-zero value, which is interpreted as an advertised PBKEYLEN (in which case it is written into the value of the SRTO\_PBKEYLEN option).

### The Conclusion Phase

Once the Caller gets its cookie, it sends a URQ\_CONCLUSION handshake message to the Listener.

The following values are set by an HSv4 Caller. Note that the same values must be used by an HSv5 Caller when the Listener has returned Version 4 in its URQ\_INDUCTION response:

- Version: 4
- Type: UDT\_DGRAM (SRT must have this legacy UDT socket type only)
- ReqType: URQ\_CONCLUSION
- ID: Socket ID of the Caller
- Cookie: the cookie previously received in the induction phase

If an HSv5 Caller receives a confirmation from a Listener that it can use the version 5 handshake, it fills in the following values:

- Version: 5
- Type: appropriate Extension Flags and Encryption Flags (see below)
- ReqType: URQ\_CONCLUSION
- ID: Socket ID of the Caller
- Cookie: the cookie previously received in the induction phase

The Destination Socket ID (in the SRT header, PH\_ID field) in this message is the socket ID that was previously received in the induction phase in the ID field in the handshake structure.

The Type field contains:

- Encryption Flags: advertised PBKEYLEN (see above)
- Extension Flags: The HS\_EXT\_ prefixed flags defined in CHandShake (see the SRT Extended Handshake section below)

The Listener responds with the same values shown above, without the cookie (which isn't needed here), as well as the extensions for HSv5 (which will probably be exactly the same).

**IMPORTANT:** *There isn't any "negotiation" here. If the values passed in the handshake are in any way not acceptable by the other side, the connection will be rejected. The only case when the Listener can have precedence over the Caller is the advertised PBKEYLEN in the Encryption Flags field in Type field. The value for latency is always agreed to be the greater of those reported by each party.*

## The Rendezvous Handshake

When two parties attempt to connect in Rendezvous mode, they are considered to be equivalent: Both are connecting, but neither is listening, and they expect to be contacted (over the same port number for both parties) specifically by the same party with which they are trying to connect. Therefore, it's perfectly safe to assume that, at some point, each party will have agreed upon the connection, and that no induction-conclusion phase split is required. Even so, the Rendezvous handshake process is more complicated.

The basics of a Rendezvous handshake are the same in HSv4 and HSv5 - the description of the HSv4 process is a good introduction for HSv5. However, HSv5 has more data to exchange and more conditions to be taken into account.

### HSv4 Rendezvous Process

Initially, each party sends an SRT control message of type UMSG\_HANDSHAKE to the other, with the following fields:

- Version: 4 (HSv4 only)
- Type: UDT\_DGRAM (HSv4 only)
- ReqType: URQ\_WAVEHAND
- ID: Socket ID of the party sending this message
- Cookie: 0

When the `srt_connect()` function is first called by an application, each party sends this message to its peer, and then tries to read a packet from its underlying UDP socket to see if the other party is alive. Upon reception of an UMSG\_HANDSHAKE message, each party initiates the second (conclusion) phase by sending this message:

- Version: 4
- Type: UDT\_DGRAM
- ReqType: URQ\_CONCLUSION
- ID: Socket ID of the party sending this message
- Cookie: 0

At this point, they are considered to be connected. When either party receives this message from its peer again, it sends another message with the ReqType field set as URQ\_AGREEMENT. This is a formal conclusion to the handshake process, required to inform the peer that it can stop sending conclusion messages (note that this is UDP, so neither party can assume that the message has reached its peer).

With HSv4 there's no debate about who is the Initiator and who is the Responder because this transaction is unidirectional, so the party that has set the SRTO\_SENDER flag is the Initiator and the other is Responder (as is usual with HSv4).

### HSv5 Rendezvous Process

The HSv5 Rendezvous process introduces a state machine, and therefore is slightly different from HSv4, although it is still based on the same message request types. Both parties start with URQ\_WAVEAHAND and use a Version value of 5. The version recognition is easy - the HSv4 client does not look at the Version value, whereas HSv5 clients can quickly recognize the version from the Version field. The parties only continue with the HSv5 Rendezvous process when Version = 5 for both. Otherwise the process continues exclusively according to HSv4 rules.

With HSv5 Rendezvous, both parties create a cookie for a process called a "cookie contest". This is necessary for the assignment of Initiator and Responder roles. Each party generates a cookie value (a 32-bit number) based on the host, port, and current time with 1 minute accuracy. This value is scrambled using an MD5 sum calculation. The cookie values are then compared with one another.

Since you can't have two sockets on the same machine bound to the same device and port and operating independently, it's virtually impossible that the parties will generate identical cookies. However, this situation may occur if an application tries to "connect to itself" — that is, either connects to a local IP address, when the socket is bound to INADDR\_ANY, or to the same IP address to which the socket was bound. If the cookies are identical (for any reason), the connection will not be made until new, unique cookies are generated (after a delay of up to one minute). In the case of an application "connecting to itself", the cookies will always be identical, and so the connection will never be made).

When one party's cookie value is greater than its peer's, it wins the cookie contest and becomes Initiator (the other party becomes the Responder).

At this point there are two "handshake flows" possible (at least theoretically): *serial* and *parallel*.

### Serial Handshake Flow

In the serial handshake flow, one party is always first, and the other follows. That is, while both parties are repeatedly sending URQ\_WAVEAHAND messages, at some point one party — let's say Alice — will find she has received a URQ\_WAVEAHAND message before she can send her next one, so she sends a URQ\_CONCLUSION message in response. Meantime, Bob (Alice's peer) has missed her URQ\_WAVEAHAND messages, and so Alice's URQ\_CONCLUSION is the first message Bob has received from her.

This process can be described easily as a series of exchanges between the first and following parties (Alice and Bob, respectively):

1. Initially, both parties are in the *waving* state. Alice sends a handshake message to Bob:
  - Version: 5
  - Type: Extension field: 0  
Encryption field: advertised PBKEYLEN



- ReqType: URQ\_WAVEHAND
- ID: Alice's socket ID
- Cookie: Created based on host/port and current time

Keep in mind that while Alice doesn't yet know if she is sending this message to an HSv4 or HSv5 peer, the values from these fields would not be interpreted by an HSv4 peer when the ReqType is URQ\_WAVEHAND.

2. Bob receives Alice's URQ\_WAVEHAND message, switches to the *attention* state. Since Bob now knows Alice's cookie, he performs a "cookie contest" (compares both cookie values). If Bob's cookie is greater than Alice's, he will become the Initiator. Otherwise, he will become the Responder.

**IMPORTANT:** *The resolution of the Handshake Role (Initiator or Responder) is essential to further processing.*

3. Then Bob responds:
  - Version: 5
  - Type: Extension field: appropriate flags if Initiator, otherwise 0  
Encryption field: advertised PBKEYLEN
  - ReqType: URQ\_CONCLUSION

**NOTE:** *If Bob is the Initiator and encryption is on, he will use either his own PBKEYLEN or the one received from Alice (if she has advertised PBKEYLEN).*

4. Alice receives Bob's URQ\_CONCLUSION message. While at this point she also performs the "cookie contest", the outcome will be the same. She switches to the *fine* state, and sends:
  - Version: 5
  - Type: Appropriate extension flags and encryption flags
  - ReqType: URQ\_CONCLUSION

**NOTE:** *Both parties always send extension flags at this point, which will contain SRT\_CMD\_HSREQ if the message comes from an Initiator, or SRT\_CMD\_HSRSP if it comes from a Responder. If the Initiator has received a previous message from the Responder containing an advertised PBKEYLEN in the encryption flags field (in the Type field), it will be used as the key length for key generation sent next in the SRT\_CMD\_KMREQ block.*

5. Bob receives Alice's URQ\_CONCLUSION message, and then does one of the following (depending on Bob's role):
  - If Bob is the Initiator (Alice's message contains SRT\_CMD\_HSRSP), he:
    - switches to the *connected* state
    - sends Alice a message with ReqType = URQ\_AGREEMENT, but containing no SRT extensions (*Extension flags* in Type should be 0)

- If Bob is the Responder (Alice's message contains SRT\_CMD\_HSREQ), he:
  - switches to *initiated* state
  - sends Alice a message with ReqType = URQ\_CONCLUSION that also contains extensions with SRT\_CMD\_HSRSP
  - awaits a confirmation from Alice that she is also connected (preferably by URQ\_AGREEMENT message)
- 6. Alice receives the above message, enters into the *connected* state, and then does one of the following (depending on Alice's role):
  - If Alice is the Initiator (received URQ\_CONCLUSION with SRT\_CMD\_HSRSP), she sends Bob a message with ReqType= URQ\_AGREEMENT.
  - If Alice is the Responder, the received message has ReqType = URQ\_AGREEMENT and in response she does nothing.
- 7. At this point, if Bob was Initiator, he is connected already. If he was a Responder, he should receive the above URQ\_AGREEMENT message, after which he switches to the *connected* state. In the case where the UDP packet with the agreement message gets lost, Bob will still enter the *connected* state once he receives anything else from Alice. If Bob is going to send, however, he has to continue sending the same URQ\_CONCLUSION until he gets the confirmation from Alice.

### Parallel Handshake Flow

The serial handshake flow described above happens in almost every case.

There is, however, a very rare (but still possible) parallel flow that only occurs if the messages with URQ\_WAVEAHAND are sent and received by both peers at precisely the same time. This might happen in one of these situations:

- if both Alice and Bob start sending URQ\_WAVEAHAND messages perfectly simultaneously,

or

- if Bob starts later but sends his URQ\_WAVEAHAND message during the gap between the moment when Alice had earlier sent her message, and the moment when that message is received (that is, if each party receives the message from its peer immediately after having sent its own),

or

- if, at the beginning of `srt_connect`, Alice receives the first message from Bob exactly during the very short gap between the time Alice is adding a socket to the connector list and when she sends her first URQ\_WAVEAHAND message

The resulting flow is very much like Bob's behaviour in the serial handshake flow, but for both parties. Alice and Bob will go through the same state transitions:

## Waving -> Attention -> Initiated -> Connected

In the *Attention* state they know each other's cookies, so they can assign roles. It is important to understand that, in contrast to serial flows, which are mostly based on request-response cycles, here everything happens completely asynchronously: the state switches upon reception of a particular handshake message with appropriate contents (the Initiator must attach the HSREQ extension, and Responder must attach the HSRSP extension).

Here's how the parallel handshake flow works, based on roles:

Initiator:

1. Waving
  - Receives URQ\_WAVEHAND message
  - Switches to Attention
  - Sends URQ\_CONCLUSION + HSREQ
2. Attention
  - Receives URQ\_CONCLUSION message, which:
    - contains no extensions:
      - switches to Initiated, still sends URQ\_CONCLUSION + HSREQ
    - contains HSRSP extension:
      - switches to Connected, sends URQ\_AGREEMENT
3. Initiated
  - Receives URQ\_CONCLUSION message, which:
    - Contains no extensions:
      - REMAINS IN THIS STATE, still sends URQ\_CONCLUSION + HSREQ
    - contains HSRSP extension:
      - switches to Connected, sends URQ\_AGREEMENT
4. Connected
  - May receive URQ\_CONCLUSION and respond with URQ\_AGREEMENT, but normally by now it should already have received payload packets.

Responder:

1. Waving
  - Receives URQ\_WAVEHAND message
  - Switches to Attention
  - Sends URQ\_CONCLUSION message (with no extensions)
2. Attention
  - Receives URQ\_CONCLUSION message with HSREQ

**NOTE:** *This message might contain no extensions, in which case the party shall simply send the empty URQ\_CONCLUSION message, as before, and remain in this state.*

- Switches to Initiated and sends URQ\_CONCLUSION message with HSRSP
3. Initiated
- Receives:
    - URQ\_CONCLUSION message with HSREQ
      - responds with URQ\_CONCLUSION with HSRSP and remains in this state
    - URQ\_AGREEMENT message
      - responds with URQ\_AGREEMENT and switches to Connected
    - Payload packet
      - responds with URQ\_AGREEMENT and switches to Connected
4. Connected
- Is not expecting to receive any handshake messages anymore. The URQ\_AGREEMENT message is always sent only once or per every final URQ\_CONCLUSION message.

Note that any of these packets may be missing, and the sending party will never become aware. The missing packet problem is resolved this way:

1. If the Responder misses the URQ\_CONCLUSION + HSREQ message, it simply continues sending empty URQ\_CONCLUSION messages. Only upon reception of URQ\_CONCLUSION + HSREQ does it respond with URQ\_CONCLUSION+ HSRSP.
2. If the Initiator misses the URQ\_CONCLUSION + HSRSP response from the Responder, it continues sending URQ\_CONCLUSION + HSREQ. The Responder must always respond with URQ\_CONCLUSION + HSRSP when the Initiator sends URQ\_CONCLUSION + HSREQ, even if it has already received and interpreted it.
3. When the Initiator switches to the Connected state it responds with a URQ\_AGREEMENT message, which may be missed by the Responder. Nonetheless, the Initiator may start sending data packets because it considers itself connected. It doesn't know that the Responder has not yet switched to the Connected state. Therefore it is exceptionally allowed that when the Responder is in the Initiated state and receives a data packet (or any control packet that is normally sent only between connected parties) over this connection, it may switch to the Connected state just as if it had received a URQ\_AGREEMENT message.
4. If the the Initiator is already switched to the Connected state it will not bother the Responder with any more handshake messages. But the Responder may be completely unaware of that (having missed the URQ\_AGREEMENT message from the Initiator). Therefore it doesn't exit the connecting state (still blocks on srt\_connect or doesn't signal connection readiness), which means that it continues sending URQ\_CONCLUSION + HSRSP messages until it receives any packet that will make it switch to the Connected

state (normally URQ\_AGREEMENT). Only then does it exit the connecting state and the application can start transmission.

### **Rendezvous Between Different Versions**

When one of the parties in a handshake supports HSv5 and the other only HSv4, the handshake is conducted according to the rules described in the HSv4 Rendezvous Process section above.

Note, though, that in the first phase the URQ\_WAVEHAND request type sent by the HSv5 party contains the `m_iVersion` and `m_iType` fields filled in as required for version 5. This happens only for the “waving” phase, and fortunately HSv4 clients ignore these fields. When switching to the conclusion phase, the HSv5 client is already aware that the peer is HSv4 and fills the fields of the conclusion handshake message according to the rules of HSv4.

---

## The SRT Extended Handshake

### HSv4 Extended Handshake Process

The HSv4 extended handshake process starts after the connection is considered established. Whatever problems may occur after this point will only affect data transmission.

Here is a representation of the HSv4 extended handshake packet structure (including the first four 32-bit segments of the SRT header):

0	1	2	3	4	5	6	7	8	9	0	1	2	3	4	5	6	7	8	9	0	1	2	3	4	5	6	7	8	9	0	1
1	Type=0x7fff															Ext {HSREQ(1),HSRSP(2)}															
info: Additional Info = undefined																															
Time Stamp (µsec)																															
Destination Socket ID																															
SRT Version {<10300h}																															
SRT Flags																															
TsbPd Resv = 0																TsbPdDelay {20..8000}															
Reserved = 0																															

The HSv4 extended handshake is performed with the use of the aforementioned “SRT Extended Messages”, using control messages with major type UMSG\_EXT.

Note that these command messages, although sent over an established connection, are still simply UDP packets. As such they are subject to all the problematic UDP protocol phenomena, such as packet loss (packet recovery applies exclusively to the payload packets). Therefore messages are sent “stubbornly” (with a slight delay between subsequent retries) until the peer responds, with some maximum number of retries before giving up. It’s very important to understand that the first message from an Initiator is sent at the same moment that the application requests transmission of the first data packet. This data packet is not held back until the extended SRT handshake is finished. The first command message is sent, followed by the first data packet, and the rest of the transmission continues without having the extended SRT handshake yet agreed upon.

This means that the initial few data packets might be sent without having the appropriate SRT settings already working, which may raise two concerns:

- *There is a delay in the application of latency to received packets* — At first, packets are being delivered immediately. It is only when the SRT\_CMD\_HSREQ message is processed that latency is applied to the received packets. The timestamp based packet delivery mechanism (TSBPD) isn’t working until then.
- *There is a delay in the application of encryption (if used) to received packets* — Packets can’t be decrypted until the SRT\_CMD\_KMREQ is processed and the keys installed. The data packets are still encrypted, but the receiver can’t decrypt them and will drop them.

The codes for commands used are the same in HSv4 and HSv5 processes. In HSv4 these are minor message type codes used with the UMSG\_EXT command, whereas in HSv5 they are in the “command” part of the extension block. The messages that are sent as “REQ” parts will be

repeatedly sent until they get a corresponding “RSP” part, up to some timeout, after which they give up and stay with a pure UDT connection.

### HSv5 Extended Handshake Process

Here is a representation of the HSv5 integrated handshake packet structure (without SRT header):

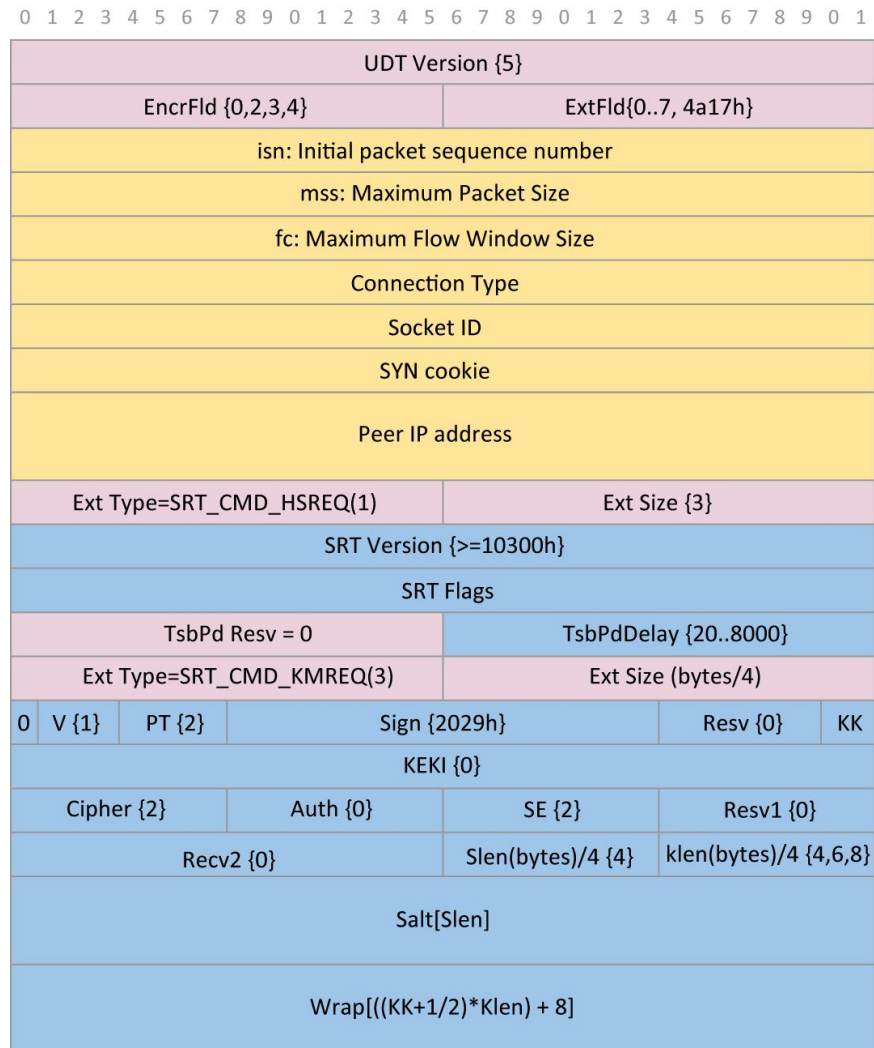

The Extension Flags subfield in the Type field in a conclusion handshake message contains one of these flags:

- HS\_EXT\_HSREQ: defines SRT characteristic data; always present
- HS\_EXT\_KMREQ: if using encryption, defines encryption block
- HS\_EXT\_CONFIG: information about extra configuration data attached (if any)

The the HSv5 packet structure (shown above) can be split into three parts:

1. The Handshake data (up to the “Peer IP Address” field)

2. The HSREQ extension
3. The KMREQ extension

Note that extensions are added only in certain situations (as described above), so sometimes there are no extensions at all. When extensions are added, the HSREQ extension is always present. The KMREQ extension is added only if encryption is requested (the passphrase is set by the SRTO\_PASSPHRASE socket option). There might be also other extensions placed after HSREQ and KMREQ.

Every extension block has the following structure:

1. a 16-bit command symbol
2. 16-bit block size (number of 32-bit words following this field)
3. a number of 32-bit fields, as specified in (2) above

What is contained in a block depends on the extension command code.

The data being received in the extension blocks in the conclusion message undergo further verification. If the values are not acceptable, the connection will be rejected. This may happen in the following situations:

1. The Version field contains 0. This means that the peer rejected the handshake.
2. The Version field was higher than 4, but no extensions were added (no extension flags set), while the rules state that they should be present. This is considered an error in the case of a URQ\_CONCLUSION message sent by the Initiator to the Responder (there can be an initial conclusion message without extensions sent by the Responder to the Initiator in Rendezvous connections).
3. Processing of any of the extension data has failed (also due to an internal error).
4. Each side declares a transmission type that is not compatible with the other. This will be described further, along with other new HSv5 features; the HSv4 client supports only and exclusively one transmission type, which is *Live*. This is indicated in the Type field in the HSv4 handshake, which must be equal to UDT\_DGRAM (2), and in the HSv5 by the extra *Congestion Control* block declaration (see below). In any case, when there's no Congestion Control type declared, *Live* is assumed. Otherwise the Congestion Control type must be exactly the same on both sides.

**NOTE:** *The TsbPd Resv and TsbPdDelay fields both refer to latency, but the use is different in HSv4 and HSv5.*

In HSv4, only the lower 16 bits (TsbPdDelay) are used. The upper 16 bits (TsbPd Resv) are simply unused. There's only one direction, so HSREQ is sent by the Sender, HSRSP by the Receiver. HSREQ contains only the Sender latency, and HSRSP contains only the Receiver latency.

This is different from HSv5, in which the latency value for the sending direction in the lower 16 bits (SndTsbPdDelay, 16 - 31 in network order) and for receiving direction is placed in the upper 16 bits (RcvTsbpdDelay, 0 - 15). The communication is bidirectional, so there are two latency values, one per direction. Therefore both HSREQ and HSRSP messages contain both the Sender and Receiver latency values.



## SRT Extension Commands

**HSREQ and HSRSP**

The SRT\_CMD\_HSREQ message contains three 32-bit fields designated as:

- SRT\_HS\_VERSION: string (0x00XXYYZZ) representing SRT version XX.YY.ZZ
- SRT\_HS\_FLAGS: the SRT flags (see below)
- SRT\_HS\_LATENCY: the latency specification

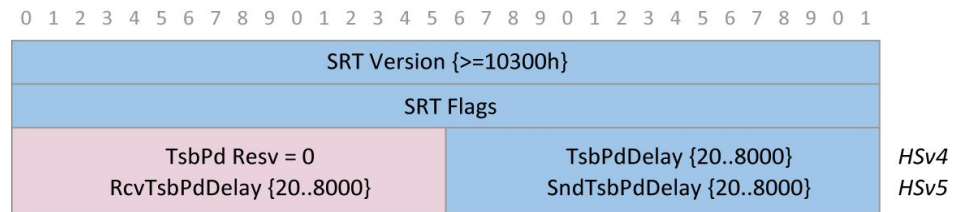

The flags (SRT Flags field) are the following bits, in order:

0. SRT\_OPT\_TSBPDSND: The party will be sending in TSBPD (Time Stamp Based Packet Delivery) mode.  
  
This is used by the Sender party to specify that it will use TSBPD mode. The Responder should respond with its setting for TSBPD reception; if it isn't using TSBPD for reception, it responds with its reception TSBPD flag not set. In HSv4, this is only used by the Initiator.
1. SRT\_OPT\_TSBPDCV: The party expects to receive in TSBPD mode.  
  
This is used by a party to specify that it expects to receive in TSBPD mode. The Responder should respond to this setting with TSBPD sending mode (HSv5 only) and set the sending TSBPD flag appropriately. In HSv4 this is only used by the Responder party.
2. SRT\_OPT\_HAICRYPT: The party includes haicrypt (legacy flag).  
  
This special legacy compatibility flag should be always set. See below for more details.
3. SRT\_OPT\_TLPKTDROP: The party will do TLPKTDROP.  
  
Declares the SRTO\_TLPKTDROP flag of the party. This is important because both parties must cooperate in this process. In HSv5, if both directions are TSBPD, both use this setting. This flag must always be set in live mode.
4. SRT\_OPT\_NAKREPORT: The party will do periodic NAK reporting.  
  
Declares the SRTO\_NAKREPORT flag of the party. This flag means that periodic NAK reports will be sent (repeated UMSG\_LOSSREPORT message when the sender seems to linger with retransmission).
5. SRT\_OPT\_REXMITFLG: The party uses the REXMIT flag.  
  
This special legacy compatibility flag should be always set. See below for more details.

6. SRT\_OPT\_STREAM: The party uses stream type transmission.

This is introduced in HSv5 only. When set, the party is using a stream type transmission (file transmission with no boundaries). In HSv4 this flag does not exist, and therefore it's always clear, which corresponds to the fact that HSv4 supports Live mode only.

### Special Legacy Compatibility Flags

The SRT\_OPT\_HAICRYPT and SRT\_OPT\_REXMITFLG fields define special cases for the interpretation of the contents in the SRT header for payload packets.

The SRT header field PH\_MSGNO contains some extra flags that occupy the most significant bits in this field (the rest are assigned to the Message Number). Some of these extra flags were already in UDT, but SRT added some more by re-assigning bits from the Message Number subfield:

1. Encryption Key flags (2 bits). Controlled by SRT\_OPT\_HAICRYPT, this field contains a value that declares whether the payload is encrypted and with which key.
2. Retransmission flag (1 bit). Controlled by SRT\_OPT\_REXMITFLG, this flag is 0 when a packet is sent the first time, and 1 when it is retransmitted (i.e. requested in a loss report). When the incoming packet is late (one with a sequence number older than the newest received so far), this flag allows the Receiver to distinguish between a retransmitted packet and a reordered packet. This is used by the "reorder tolerance" feature described in the API documentation under SRTO\_LOSSMAXTTL socket option.

As of version 1.2.0 both these fields are in use, and therefore both these flags must always be set. In theory, there might still exist some SRT versions older than 1.2.0 where these flags are not used, and these extra bits remain part of the "Message Number" subfield.

In practice there are no versions around that do not use encryption bits, although there might be some old SRT versions still in use that do not include the Retransmission field, which was introduced in version 1.2.0. In practice both these flags must be set in the version that has them defined. They might be reused in future for something else, once all versions below 1.2.0 are decommissioned, but the default is for them to be set.

The SRT\_HS\_LATENCY field defines Sender/Receiver latency.

It is split into two 16-bit parts. The usage differs in HSv4 and HSv5.

In HSv4 only the lower part (bits 16 - 31) is used. The upper part (bits 0 - 15) is always 0. The interpretation of this field is as follows:

- Receiver party: Receiver latency
- Sender party: Sender latency

In HSv5 both 16-bit parts of the field are used, and interpreted as follows:

- Upper 16 bits (0 - 15): Receiver latency
- Lower 16 bits (16 - 31): Sender latency

The characteristics of Sender and Receiver latency are the following:

1. Sender latency is the minimum latency that the Sender wants the Receiver to use.
2. Receiver latency is the (minimum) value that the Receiver wishes to apply to the stream that it will be receiving.

Once these values are exchanged via the extended handshake, an effective latency is established, which is always the maximum of the two. Note that latency is defined in a specified direction. In HSv5, a connection is bidirectional, and a separate latency is defined for each direction.

The Initiator sends an HSREQ message, which declares the values on its side. The Responder calculates the maximum values between what it receives in the HSREQ and its own values, then sends an HSRSP with the effective latencies.

Here is an example of an HSv5 bidirectional transmission between Alice and Bob, where Alice is Initiator:

1. Alice and Bob set the following latency values:
  - Alice: `SRTO_PEERLATENCY = 250 ms`, `SRTO_RCVLATENCY = 550 ms`
  - Bob: `SRTO_PEERLATENCY = 500 ms`, `SRTO_RCVLATENCY = 300 ms`
2. Alice defines the latency field in the HSREQ message:
  - `hs[SRT_HS_LATENCY] = { 250, 550 }; // { Lower, Upper }`
3. Bob receives it, sets his options, and responds with HSRSP:
  - `SRTO_RCVLATENCY = max(300, 250); //<-- 250:Alice's PEERLATENCY`
  - `SRTO_PEERLATENCY = max(500, 550); //<-- 550:Alice's RCVLATENCY`
  - `hs[SRT_HS_LATENCY] = { 550, 300 };`
4. Alice receives this HSRSP and sets:
  - `SRTO_RCVLATENCY = 550;`
  - `SRTO_PEERLATENCY = 300;`
5. We now have the effective latency values:
  - For transmissions from Alice to Bob: 300 ms
  - For transmissions from Bob to Alice: 550 ms

Here is an example of an HSv4 exchange, which is simpler because there's only one direction. We'll refer to Alice and Bob again to be consistent with the Initiator/Responder roles in the HSv5 example:

1. Alice sets `SRTO_LATENCY` to 250 ms
2. Bob sets `SRTO_LATENCY` to 300 ms
3. Alice sends `hs[SRT_HS_LATENCY] = { 250, 0 };` to Bob
4. Bob does `SRTO_LATENCY = max(300, 250);`
5. Bob sends `hs[SRT_HS_LATENCY] = {300, 0};` to Alice

## 6. Alice sets SRTO\_LATENCY to 300

Note that the SRTO\_LATENCY option in HSv5 sets both SRTO\_RCVLATENCY and SRTO\_PEERLATENCY to the same value, although when reading, SRTO\_LATENCY is an alias to SRTO\_RCVLATENCY.

Why is the Sender latency updated to the effective latency for that direction? Because the TLPKTDROP mechanism, which is used by default in Live mode, may cause the Sender to decide to stop retransmitting packets that are known to be too late to retransmit. This latency value is one of the factors taken into account to calculate the time threshold for TLPKTDROP.

## KMREQ and KMRSP

KMREQ and KMRSP contain the KMX (key material exchange) message used for encryption. The most important part of this message is the AES-wrapped key (see the Encryption documentation for details). If the encryption process on the Responder side was successful, the response contains the same message for confirmation. Otherwise it's one single 32-bit value that contains the value of SRT\_KMSTATE type, as an error status.

Note that when the encryption settings are different at each end, then the connection is still allowed, but with the following restrictions:

- If the Initiator declares encryption, but the Responder does not, then the Responder responds with SRT\_KM\_S\_NOSECRET status. This means that the Responder will not be able to decrypt data sent by the Initiator, but the Responder can still send unencrypted data to the Initiator.
- If the Initiator did not declare encryption, but the Responder did, then the Responder will attach SRT\_CMD\_KMRSP (despite the fact that the Initiator did not send SRT\_CMD\_KMREQ) with SRT\_KM\_S\_UNSECURED status. The Responder won't be able to send data to the Initiator (more precisely, it will send scrambled data, not able to be decrypted), but the Initiator will still be able to send unencrypted data to the Responder.
- If both have declared encryption, but have set different passwords, the Responder will send a KMRSP block with an SRT\_KM\_S\_BADSECRET value. The transmission in both directions will be "scrambled" (encrypted and not decryptable).

The value of the encryption status can be retrieved from the SRTO\_SNDKMSTATE and SRTO\_RCVKMSTATE options. The legacy (or unidirectional) option SRTO\_KMSTATE resolves to SRTO\_RCVKMSTATE by default, unless the SRTO\_SENDER option is set to true, in which case it resolves to SRTO\_SNDKMSTATE.

The values retrieved from these options depend on the result of the KMX process:

1. If only one party declares encryption, the KM state will be one of the following:
  - For the party that declares no encryption:
    - RCVKMSTATE: NOSECRET
    - SNDKMSTATE: UNSECURED

- Result: This party can send payloads unencrypted, but it can't decrypt packets received from its peer.
- For the party that declares encryption:
  - RCVKMSTATE: UNSECURED
  - SNDKMSTATE: NOSECRET
  - Result: This party can receive unencrypted payloads from its peer, and will be able to send encrypted payloads to the peer, but the peer won't decrypt them.
- 2. If both declare encryption, but they have different passwords, then both states are SRT\_KM\_S\_BADSECRET. In such a situation both sides may send payloads, but the other party won't decrypt them.
- 3. If both declare encryption and the password is the same on both sides, then both states are SRT\_KM\_S\_SECURED. The transmission will be correctly performed with encryption in both directions.

Note that due to the introduction of the bidirectional feature in HSv5 (and therefore the Initiator and Responder roles), the old HSv4 method of initializing the crypto objects used for security is used only in one of the directions. This is now called "forward KMX":

1. The Initiator initializes its Sender Crypto (TXC) with preconfigured values. The SEK and SALT values are random-generated.
2. The Initiator sends a KMX message to the Receiver.
3. The Receiver deploys the KMX message into its Receiver Crypto (RXC)

This is the general process of Security Association done for the "forward direction", that is, when done by the Sender. However, as there's only one KMX process in the handshake, in HSv5 this must also initialize the crypto in the opposite direction. This is accomplished by "reverse KMX":

1. The Initiator initializes its Sender Crypto (TXC), like above, and then clones it to the Receiver Crypto.
2. The Initiator sends a KMX message to the Responder.
3. The Responder deploys the KMX message into its Receiver Crypto (RXC)
4. The Responder initializes its Sender Crypto by cloning the Receiver Crypto, that is, by extracting the SEK and SALT from the Receiver Crypto and using them to initialize the Sender Crypto (clone the keys).

This way the Sender (being a Responder) has the Sender Crypto initialized in a manner very similar to that of the Initiator. The only difference is that the SEK and SALT parameters in the crypto are:

- random-generated on the Initiator side

- extracted (on the Responder side) from the Receiver Crypto, which was configured by the incoming KMX message

The extra operations defined as “reverse KMX” happen exclusively in the HSv5 handshake.

The encryption key (SEK) is normally configured to be refreshed after a predefined number of packets has been sent. To ensure the “soft handoff” to the new key, this process consists of three activities performed in order:

1. Pre-announcing of the key (SEK is sent by Sender to Receiver)
2. Switching the key (at some point packets are encrypted with the new key)
3. Decommissioning the key (removing the old, unused key)

Pre-announcing is done using an SRT Extended Message with the SRT\_CMD\_KMREQ extended type, where only the “forward KMX” part is done. When the transmission is bidirectional, the key refreshing process happens completely independently for each direction, and it’s always initiated by the sending side, independently of Initiator and Responder roles (actually, these roles are significant only up to the moment when the connection is considered established).

The decision as to when exactly to perform particular activities belonging to the key refreshing process is made when the number of sent packets exceeds a certain value (up to the moment of the connection or previous refresh), which is controlled by the SRTO\_KMREFRESHRATE and SRTO\_KMPREANNOUNCE options:

1. Pre-announce: when # of sent packets > SRTO\_KMREFRESHRATE - SRTO\_KMPREANNOUNCE
2. Key switch: when # of sent packets > SRTO\_KMREFRESHRATE
3. Decommission: when # of sent packets > SRTO\_KMREFRESHRATE + SRTO\_KMPREANNOUNCE

In other words, SRTO\_KMREFRESHRATE is the exact number of transmitted packets for which a key switch happens. The Pre-announce happens SRTO\_KMPREANNOUNCE packets earlier, and Decommission happens SRTO\_KMPREANNOUNCE packets later. The SRTO\_KMPREANNOUNCE value serves as an intermediate delay to make sure that from the moment of switching the keys the new key is deployed on the Receiver, and that the old key is not decommissioned until the last packet encrypted with that key is received.

The following activities occur when keys are refreshed:

1. Pre-announce: The new key is generated and sent to the Receiver using the SRT Extended Message SRT\_CMD\_KMREQ. The received key is deployed into the Receiver Crypto. The Receiver sends back the same message through SRT\_CMD\_KMRSP as a confirmation that the refresh was successful (if it wasn’t, the message contains an error code).
2. Key Switch: The Encryption Flags in the PH\_MSGNO field get toggled between EK\_EVEN and EK\_ODD. From this moment on, the opposite (newly generated) key is used.

3. Decommission: The old key (the key that was used with the previous flag state) is decommissioned on both the Sender and Receiver sides. The place for the key remains open for future key refreshing.

**NOTE:** *The handlers for KMREQ and KMRSP are the same for handling the request coming through an SRT Extended Message and through the handshake extension blocks, except that in case of the SRT Extended Message only one direction (forward KMX) is updated. HSv4 relies only on these messages, so there's no difference between initial and refreshed KM exchange. In HSv5 the initial KM exchange is done within the handshake in both directions, and then the key refresh process is started by the Sender and it updates the key for one direction only.*

## SRT Congestion Control

The SRT Congestion Control feature (supported by HSv5 only) adds functionality similar to the “congestion control” class from UDT.

Its value is a string with the name of the SRT Congestion Control type. The default is “live”. SRT version 1.3.0 contains an additional optional Congestion Control type called “file”, within which it is possible to designate a stream mode and a message mode (the “live” Congestion Control may only use the message mode, with one message per packet).

The SRT Congestion Control feature is not obligatory when not present. The “live” Congestion Control type is used by default.

For an HSv4 party (which doesn't support this feature) the Congestion Control type is assumed to be “live”. The “file” Congestion Control type reintroduces the old UDT features for stream transmission (together with the SRT\_OPT\_STREAM flag) and messages that can span multiple UDP packets. The Congestion Control types differ in the way the transmission is handled, how various transmission settings are applied, and how they handle any special phenomena that happen during transmission.

The “file” Congestion Control type is based on the original CUDTCC class from UDT, and the rules for congestion control are copied from there. However, it contains many changes and allows the selection of the original UDT code in places that have been modified in SRT to support live transmission.

## Stream ID (SID)

This feature is supported by HSv5 only. Its value is a string of the user's choice that can be passed from the Caller to the Listener.

The Stream ID is a string of up to 512 characters that an Initiator can pass to a Responder. To use this feature, an application should set it on a Caller socket using the SRTO\_STREAMID option. Upon connection, the accepted socket on the Listener side will have exactly the same value set, and it can be retrieved using the same option. This gives the Listener a chance to decide what to do with this connection — such as to decide which stream to send in the case where the Listener is the stream Sender. This feature is not intended to be used for Rendezvous connections.





# Sample Implementation — HSv4 (Legacy) Caller/Listener Handshake with SRT Extensions

## Part 1 of 4: Begin HSv4 UDT Caller/Listener Handshake

### Peer A with libsrtp 1.1.5 (Caller + Sender)

```

A.State = OPENED
A.StartTime = now
A.Sender = true
A.Latency(ms) = 25
A.klen(bytes) = 24
A.pwd = "sharedsecret"
A.SockID = genID()
    
```

```

Ahs0{
  .Flag = 1
  .Type = UMSG_HANDSHAKE(0)
  .TimeStamp = now - StartTime
  .ID = A.DstSockID = 0
  .cif.hs.Version = 4
  .cif.hs.Type = DGRAM(2)
  .cif.hs.ISN = rand()
  .cif.hs.mss = A.mss = 1500
  .cif.hs.fc = A.fc
  .cif.hs.ConnType = REGULAR {1}
  .cif.hs.ID = A.SockID
  .cif.hs.Cookie = 0
  .cif.hs.PeerIP = B.IP
  A.State = CONNECTING
    
```

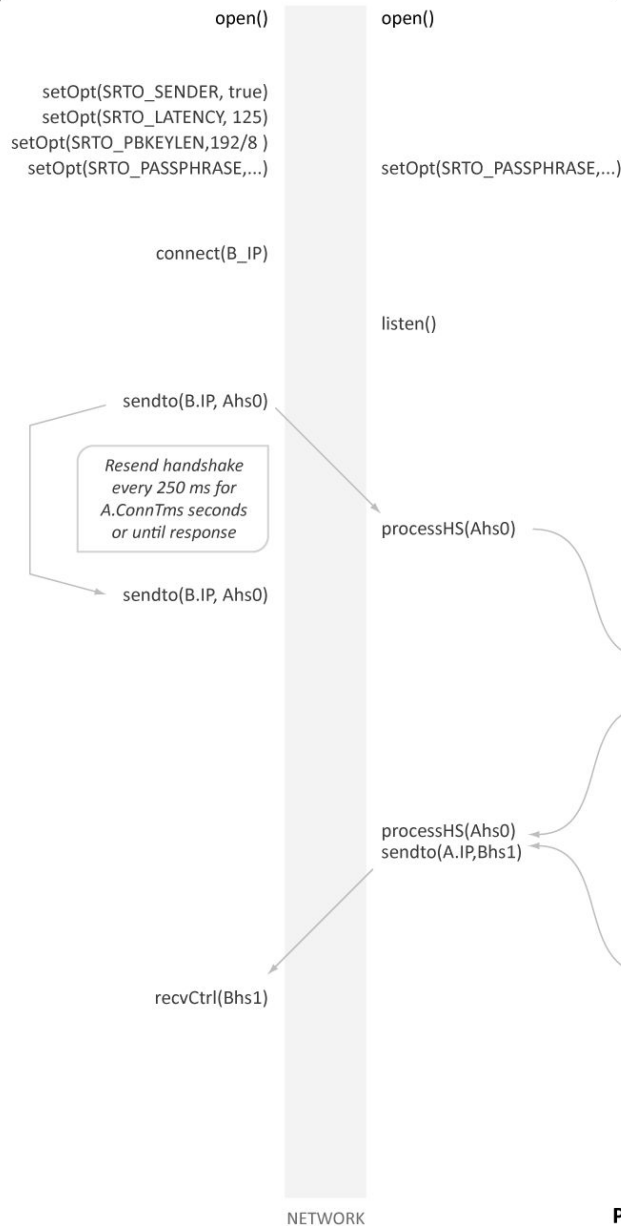

### Peer B with libsrtp 1.1.5 (Listener + Receiver)

```

B.State = OPENED
B.StartTime = now
B.Sender = false
B.Latency(ms) = 20
A.klen(bytes) = 0
B.pwd = "sharedsecret"
B.SockID = genID()
    
```

```

B.State = LISTENING
    
```

```

Bhs1{ } = Ahs0{ }
  .TimeStamp = now - B.StartTime
  .ID = .cif.hs.ID
  .cif.hs.ConnType = REGULAR {1}
  .cif.hs.ID : A.SockID
  .cif.hs.Cookie = B.Cookie
  .cif.hs.Cookie = md5(B.CookieStr)
  .cif.hs.PeerIP = B.IP
    
```

```

Bhs1{ } = Ahs0{ }
  .TimeStamp = now - B.StartTime
  .ID = .cif.hs.ID
  cif.hs.Version = 5
  .cif.hsv5.EncrFlg = B.klen/8
  .cif.hsv5.ExtFlg = 4a17h
  .cif.hs.ConnType = REGULAR {1}
  .cif.hs.ID : A.SockID
  .cif.hs.Cookie = B.Cookie
  .cif.hs.Cookie = md5(B.CookieStr)
  .cif.hs.PeerIP = A.IP
    
```

HSv5 Forward Compatibility

### Peer B with libsrtp 1.3.0 (Listener + Receiver)

- HSv4 UDT4 Handshake packet; Ahs0 = Handshake step 0 from party A
- TimeStamp was not set in UDT4 for control packets
- DGRAM {2} is interpreted as unknown in UDT wireshark plugin based on draft.
  - draft: STREAM{0},DGRAM{1}
  - code: STREAM{1},DGRAM{2}

Code values are in sync with Linux socket values SOCK\_STREAM and SOCK\_DGRAM.

- HSv4 UDT4 Handshake packet
- in UDT4 code: copy from Ahs0 kept so A.SockID is present here. Draft is vague about this so implementation is de-facto std.
- in UDT4 code: copy from Ahs0 kept so B.IP is present here. Draft is vague about this so implementation is de-facto std
- HSv5 Handshake Packet
- These HSv5 fields are ignored by HSv4 calling peers.

## Sample Implementation — HSv4 (Legacy) Caller/Listener Handshake with SRT Extensions (cont'd)

### Part 2 of 4: Begin HSv4 UDT Caller/Listener Conclusion Phase

Peer A with libsrtp 1.1.5 (Caller + Sender)

Peer B with libsrtp 1.1.5 (Listener + Receiver)

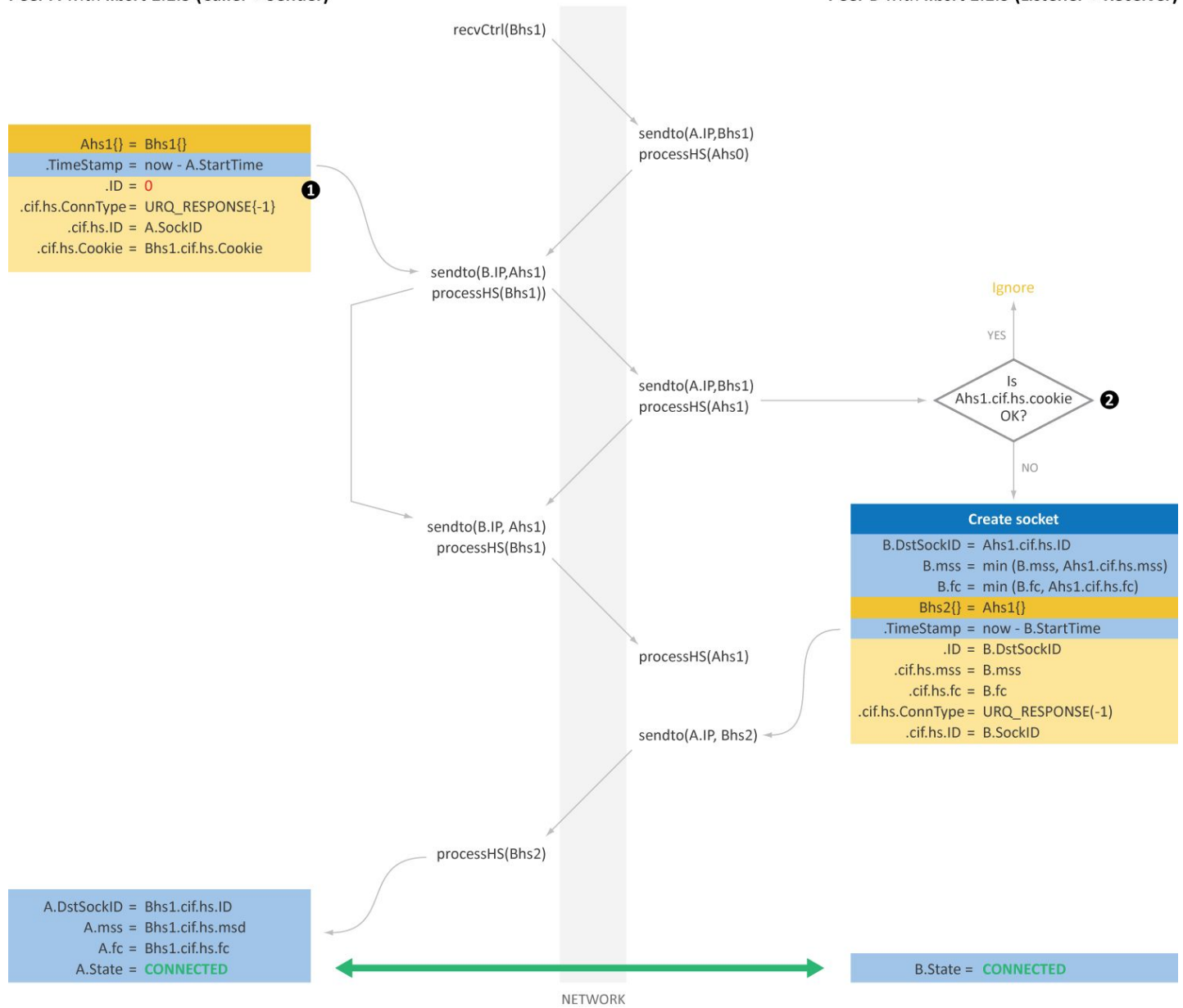

1. We must continue to use 0 for destination ID here since the Listener did not provide its Socket ID yet: cif.hs.ID contains our own SockID from Ahs0
2. Cookie is generated by Listener (B) but transmitted to A and we verify here that A sent it back in Ahs1

## Sample Implementation — HSv4 (Legacy) Caller/Listener Handshake with SRT Extensions (cont'd)

### Part 3 of 4: Begin HSv4 UDT Caller/Listener Conclusion Phase

#### Peer A with libsrt 1.1.5 (Caller + Sender)

##### HSv4 Initiator Role (Sender) ①

```

Create encrypt context if A.klen > 0
Sek = PRNG(A.klen)
Salt = PRNG(SALTLEN)
Kek = PBKDF2(A.pwd,Salt,2048,A.klen)
    
```

```

SrtReq{
    .Flag = 1
    .Type = UMSG_EXT{7FFFh}
    .Reserved = SRT_CMD_HSREQ{1}
    .TimeStamp = now - A.StartTime
    .ID = A.DstSockID
    .cif.srtext.version = 10203h
    .cif.srtext.flags = 25h
    .cif.srtext.tsbpddelay = A.Latency(ms)
    }
    
```

```

Cx.Latency = SrtRsp.srtext.tsbpddelay)
    
```

```

KmReq{
    .Flag = 1
    .Type = UMSG_EXT{7FFFh}
    .Reserved = SRT_CMD_KMREQ{3}
    .TimeStamp = now - A.StartTime
    .ID = A.DstSockID
    .kmext.vpt = 12h
    .kmext.sign = 2029h
    .kmext.kk = 01h
    .kmext.KEKI = 0
    .kmext.Cipher = AES-CTR {2}
    .kmext.Auth = none {0}
    .kmext.se = TSSRT {2}
    .kmext.Slen = SALTLEN{ 4}
    .kmext.klen = A.klen
    .kmext.Salt[] = PRNG(SALTLEN)
    .kmext.Wrap[] = AESkw(Kek,Sek)
    }
    
```

```

A.KmState = SECURING
    
```

#### Peer B with libsrt 1.1.5 (Listener + Receiver)

##### ① HSv4 Responder Role (Receiver)

```

Cx.Latency = max(B.Latency,SrtReq
.cif.srths.tsbpddelay)
SrtRsp{
    .Flag = 1
    .Type = UMSG_EXT{7FFFh}
    .Reserved = SRT_CMD_HSRSP{2}
    .TimeStamp = now - B.StartTime
    .ID = B.DstSockID
    .cif.srtext.version = 10105h
    .cif.srtext.flags = 1eh
    .cif.srtext.tsbpddelay = Cx.Latency(ms)
    }
    
```

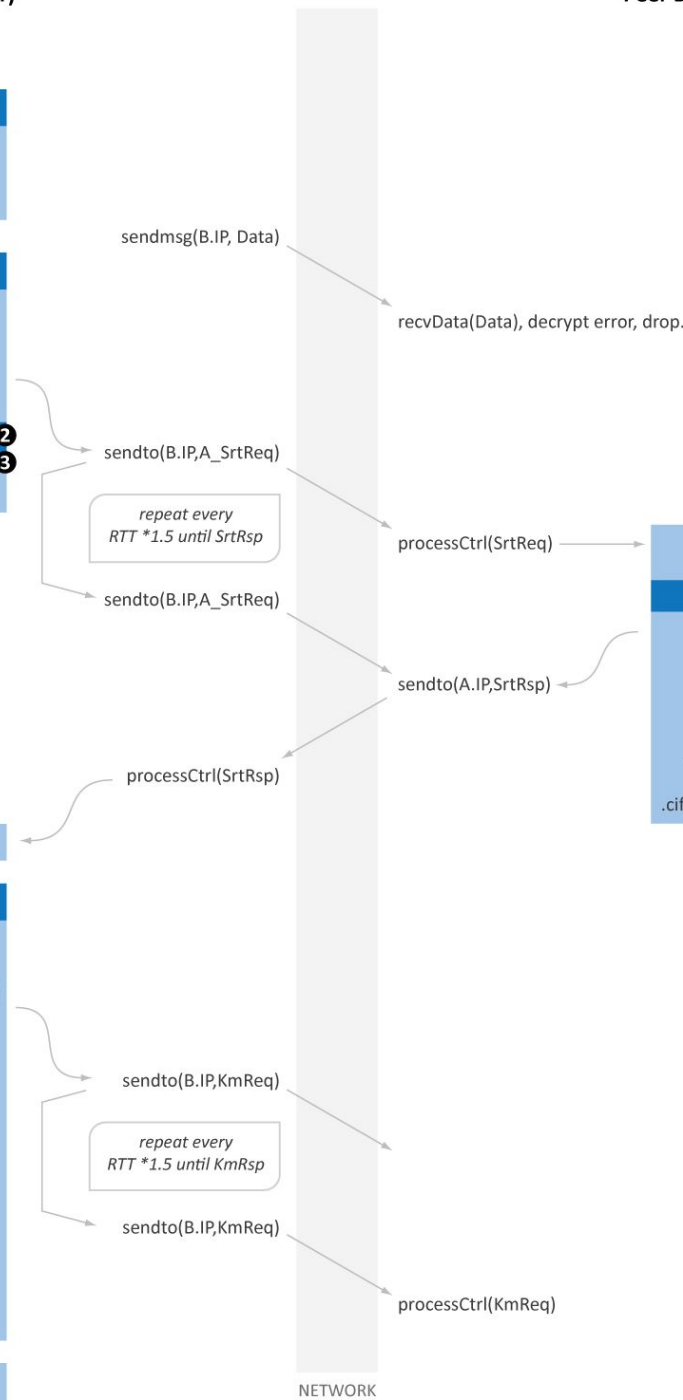

- From this point UDT4 handshake is completed, sockets are connected, and the peer that is the Sender (could be any of Caller, Listener, or Rendezvous) initiates the SRT Handshake.
- Version 1.2.3

- 01h: TsbPD sender  
02h: TsbPD receiver  
04h: HaiCrypt supported
- 01h: TsbPD sender  
02h: TsbPD receiver  
04h: HaiCrypt supported

- 08h: TLPktDrop  
10h: NAK Report  
20h: ReXmit Flag
- 08h: TLPktDrop  
10h: NAK Report  
20h: ReXmit Flag

# Sample Implementation — HSv4 (Legacy) Caller/Listener Handshake with SRT Extensions (cont'd)

## Part 4 of 4: HSv4 UDT Caller/Listener Conclusion Phase

Peer A with libsrtp 1.1.5 (Caller + Sender)

HSv4 Initiator Role (Sender)

Peer B with libsrtp 1.1.5 (Listener + Receiver)

HSv4 Responder Role (Receiver)

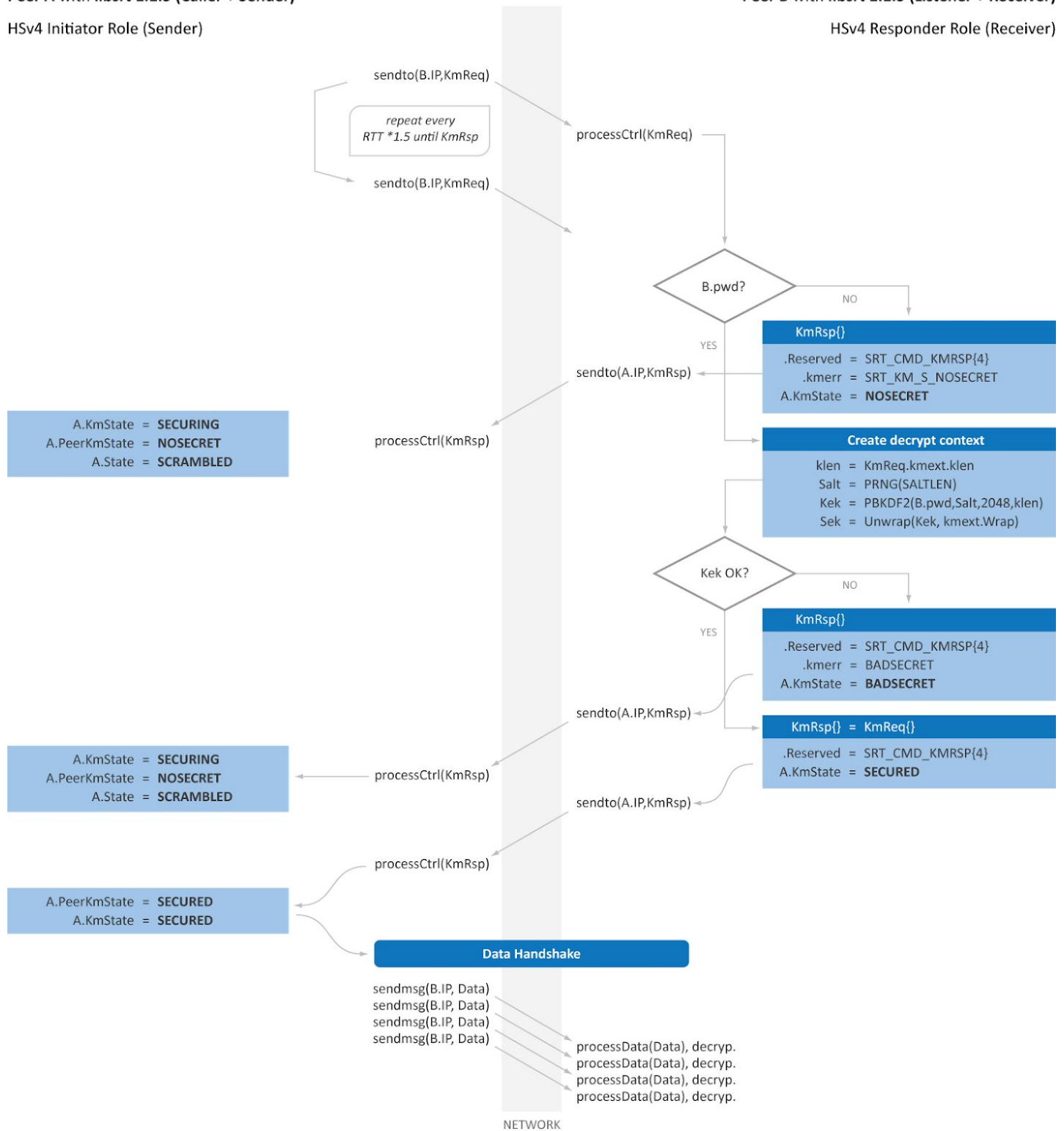

## Terminology

Term	Description
AEAD	Authenticated Encryption with Associated Data
AES	Advanced Encryption Standard
AESkw	AES key wrap not specified ([RFC3394] or [ANSX9.102])
AESKW	AES Key Wrap with associated data authentication [ANSX9.102]
ARM	Advanced RISC Machine (Texas Instrument processor)
CCM	Counter with CBC-MAC
CTR	Counter
DSP	Digital Signal Processor
DVB	Digital Video Broadcast
DVB-CA	DVB - Conditional Access
ECB	Electronic Code Book
ECM	Entitlement Control Message (DVB/MPEG)
EKT	Encrypted Key Transport (SRTP)
eSEK	Even SEK
FIPS	Federal Information Processing Standard
GCM	Galois/Counter mode
GDOI	Group Domain Of Interpretation
GOP	Group Of Pictures
HDCP	High-bandwidth Digital Content Protection
HMAC	Hash-based Message Authentication Code
HTTP	Hypertext Transfer Protocol
HTTPS	HTTP Secure
IV	Initialisation Vector
KEK	Key Encrypting Key
LSB	Least Significant Bits
MAC	Message Authentication Code

MD5	Message Digest 5
MIKEY	Multimedia Internet KEYing
MPEG	Motion Picture Expert Group
MSB	Most Significant Bits
oSEK	Odd SEK
PBKDF2	Password-Based Key Derivation Function version 2
PES	Packetized Elementary Stream (MPEG)
PKCS	Public-Key Cryptography Standards
PRNG	Pseudo Random Number Generator
RISC	Reduced Instruction Set Computer
RTP	Real-time Transport Protocol
SEK	Stream Encrypting Key
SHA	Secure Hash Algorithm
SIV	Synthetic Initialisation Vector
SO	Security Officer
SRT	Secure Reliable Transport
SRTP	Secure Real-time Transport Protocol
SSL	Secure Socket Layer
TP	Transmission Payload
TS	Transport Stream (MPEG)
TU	Transmission Unit
UDP	User Datagram Protocol

## References

### SRT Alliance

- [SRT Deployment Guide](#)

### SRT on GitHub

- [API.md](#)
- [build\\_iOS.md](#)
- [encryption.md](#)
- [live-streaming.md](#)
- [reporting.md](#)
- [stransmit.md](#)
- [why-srt-was-created.md](#)
- [handshake.md](#)

### UDT

- <http://udt.sourceforge.net/doc.html>

### Protocol Specification

- UDT Internet Draft (04/12/2010): [draft-gg-udt-03.txt](#)

### User Manual

- [UDT version 4](#)
- [UDT version 3](#)

### Technical Papers

- UDTv4: Improvements in Performance and Usability  
Yunhong Gu and Robert L. Grossman  
GridNets 2008, Beijing, China, October 8-10, 2008.  
[Paper \(PDF\) \[244 KB\]](#)      [Presentation \(PPT\) \[171 KB\]](#)
- UDT: UDP-based Data Transfer for High-Speed Wide Area Networks  
Yunhong Gu and Robert L. Grossman  
Computer Networks (Elsevier). Volume 51, Issue 7. May 2007.
- Supporting Configurable Congestion Control in Data Transport Services  
Yunhong Gu and Robert L. Grossman  
SC 2005, Nov 12 - 18, Seattle, WA, USA  
[Paper \(PDF\) \[260 KB\]](#)      [Presentation \(PPT\) \[171 KB\]](#)
- Optimizing UDP-based Protocol Implementation  
Yunhong Gu and Robert L. Grossman

PFLDNet 2005, Lyon, France, Feb. 2005

[Paper \(PDF\) \[259 KB\]](#)      [Presentation \(PPT\) \[272 KB\]](#)

- Experiences in Design and Implementation of a High Performance Transport Protocol  
Yunhong Gu, Xinwei Hong, and Robert L. Grossman  
SC 2004, Nov 6 - 12, Pittsburgh, PA, USA.

[Paper \(PDF\) \[349 KB\]](#)      [Presentation \(PPT\) \[490 KB\]](#)

- An Analysis of AIMD Algorithms with Decreasing Increases  
Yunhong Gu, Xinwei Hong and Robert L. Grossman  
First Workshop on Networks for Grid Applications (Gridnets 2004), Oct. 29, San Jose, CA, USA.

[Paper \(PDF\) \[332 KB\]](#)      [Presentation \(PPT\) \[313 KB\]](#)

- SABUL: A Transport Protocol for Grid Computing  
Yunhong Gu and Robert L. Grossman  
Journal of Grid Computing, 2003, Volume 1, Issue 4, pp. 377-386

[Paper \(PDF\) \[271 KB\]](#)

#### Presentations

- [UDT: Breaking the Data Transfer Bottleneck](#), Oct. 2005. ([Updated version](#), Aug. 2009)
- [An Introduction to UDT](#): Spring 2005 Internet2 Member Meeting, Arlington, VA, May 2 - 5, 2005.
- [UDT: UDP-based Data Transfer](#): PFLDNet 2004, Chicago, IL, Feb. 17 - 18, 2004.
- An Introduction to SABUL/UDT: ESCC/Internet2 Techs Workshop, Lawrence, KS, August 4 - 7, 2003.
- [A UDT Tutorial](#) (SC 2004, outdated)

#### Encryption

- [ANSX9.102] Accredited Standards Committee, Wrapping of Keys and Associated Data, ANS X9.102, not for free document.
- [FIPS 140-2] Security Requirements for Cryptographic Modules, NIST, [FIPS PUB 140-2](#), May 2001.
- [FIPS 140-3] Security Requirements for Cryptographic Modules, NIST, [FIPS PUB 140-3](#), December 2009.
- [SP800-38A] Recommendation for Block Cipher Modes of Operation, M. Dworkin, NIST, [FP800-38A](#), December 2001.
- [HDCP2] High-bandwidth Digital Content Protection System, Interface Independent Adaptation, Revision 2.0, [HDCP IIA 2.0](#), Digital Content Protection, LLC, October 2008.
- [PKCS5] [PKCS #5 v2.0 Password-Based Cryptography Standard](#), RSA Laboratories, March 1999.
- [RFC2998] PKCS #5: Password-Based Cryptography Specification Version 2.0, B. Kaliski, [RFC2898](#), September 2000.



- [RFC3394] Advanced Encryption Standard (AES) Key Wrap Algorithm, J. Schaad, R. Housley, [RFC3394](#), September 2002.
- [RFC3547] The Group Domain of Interpretation, M. Baugher, B. Weis, T. Hardjono, H. Harney, [RFC3547](#), July 2003.
- [RFC3610] Counter with CBC-MAC (CCM), D. Whiting, R. Housley, N. Ferguson, [RFC3610](#), September 2003.
- [RFC3711] The Secure Real-time Transport Protocol (SRTP), M. Baugher, D. McGrew, M. Naslund, E. Carrara, K. Norrman, [RFC3711](#), March 2004.
- [RFC3830] MIKEY: Multimedia Internet KEYing, J. Arkko, E. Carrara, F. Lindholm, M. Naslund, K. Norrman, [RFC3830](#), August 2004.
- [RFC5297] Synthetic Initialization Vector (SIV) Authenticated Encryption Using the Advanced Encryption Standard (AES), D. Harkins, [RFC5297](#), October 2008.
- [RFC5649] Advanced Encryption Standard (AES) Key Wrap with Padding Algorithm, R. Housley, M. Dworkin, [RFC5649](#), August 2009.
- [RFC6070] PBKDF2 Test Vectors
- [SRTP-EKT] Encrypted Key Transport for Secure RTP, D. McGrew, F. Andreasen, D. Wing, K. Fisher, [draft-ietf-avt-srtp-ekt-02](#), March 2011.